



037

Mund-, Kiefer- und
Gesichtschirurgie
Oral Maxillo-Facial
Surgery
Cirugía oral y maxilofacial
Chirurgia maxillo-facciale



037

Serviettenhalter, Fingerschützer, Mundkeile
Napkin Holder Finger, Protector Mouth Gags
Porta servilletas, Dedales, Abrebocas
Porta-salviette, Protettore per dita, Apribocca



ADAMS
037-101-001



LANGENBECK
037-105-001



LANGENBECK
037-105-002



LANGENBECK
037-105-003

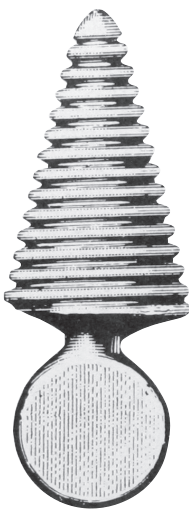

MAUNDER
037-108-100 10,0 cm / 4"



PITHA
037-111-001

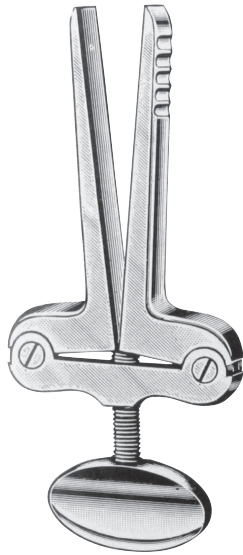

HEISTER
037-120-130 13,0 cm / 5"



MOLT / DOYEN-JANSEN
037-123-110 11,0 cm / 4 1/2"



MOLT / DOYEN-JANSEN
037-123-140 14,0 cm / 5 1/2"



DENHART
037-125-120 12,0 cm / 4 3/4"

DENHART
037-126-002
 Silikonbacken, allein (Paar)
 Silicon jaws, only (pair)
 Bocas de silicona, sueltas (par)
 Bocca da silicona, sola (paio)

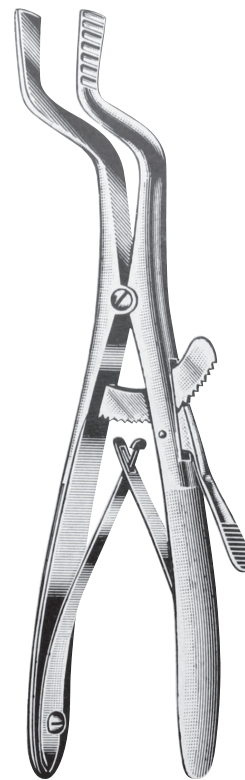

ROER-KÖNIG
037-127-160 16,0 cm / 6 1/4"
037-127-200 20,0 cm / 8"



037-142-010

Mundsperrer-Rahmen
Frame for Mouth Gag
Bastidor para abrebooca
Telaio per apribocca

KILNER-DOUGHTY

037-142-000

komplett, bestehend aus Rahmen und 3 Zungenspatel Fig. 1 bis 3, 2 Zahnplatten und 1 Gaumenplatte
complete, consisting of frame and 3 tongue depressors no. 1 to 3, 2 tooth plates and 1 palate plate
completo, consiste de bastidor y 3 babajalenguas no. 1 hasta 3, 2 placas para dientes y 1 placa paladar
completo, composto di telaio e 3 abassalingua no. 1 fino a 3, 2 placche per denti e 1 placa per palato



FIG. 1 29 x 70 mm
037-142-001 13,5 cm / 5 1/4"



FIG. 2 34 x 80 mm
037-142-002 13,5 cm / 5 1/4"



FIG. 3 38 X 85 mm
037-142-003 13,5 cm / 5 1/4"



037-150-010

Mundsperrer-Rahmen
 Frame for Mouth Gag
 Bastidor para abreboca
 Telaio per apribocca



DAVIS-BOYLE

037-150-001 13,5 cm / 5 1/4" 25 x 108 mm

Zungenspatel mit fester Absaugung
 Tongue Depressor with fixed suction tube
 Bajalengua con tubo de succión fijo
 Abassalingua con tubo di aspirazione fisso

DAVIS-BOYLE

037-150-000

komplett, bestehend aus Rahmen und fünf Zungenspatel Fig. 1 bis 5
 complete, consisting of frame and five tongue depressors no. 1 to 5
 completo, consiste de bastidor y cinco babajalenguas no. 1 hasta 5
 completo, composto di telaio e cinque abassalingua no. 1 fino a 5



DAVIS-BOYLE

037-150-002 13,5 cm / 5 1/4" 25 x 95 mm

Zungenspatel mit fester Absaugung
 Tongue Depressor with fixed suction tube
 Bajalengua con tubo de succión fijo
 Abassalingua con tubo di aspirazione fisso



DAVIS-BOYLE

037-150-003 13,5 cm / 5 1/4" 24 x 80 mm

Zungenspatel mit fester Absaugung
 Tongue Depressor with fixed suction tube
 Bajalengua con tubo de succión fijo
 Abassalingua con tubo di aspirazione fisso



DAVIS-BOYLE

037-150-004 13,5 cm / 5 1/4" 23 x 65 mm

Zungenspatel mit fester Absaugung
 Tongue Depressor with fixed suction tube
 Bajalengua con tubo de succión fijo
 Abassalingua con tubo di aspirazione fisso



DAVIS-BOYLE

037-150-005 13,5 cm / 5 1/4" 20 x 30 mm

Zungenspatel ohne Absaugung
 Tongue Depressor without suction tube
 Bajalengua sin tubo de succión fijo
 Abassalingua senza tubo di aspirazione fisso



037

Mundsperrer
Mouth Gags
Abrebocas
Apribocca



MC IVOR

037-160-000

komplett mit drei Zungenspatel
complete with three tongue depressors
completo con tres babajalenguas
completo e tre abassalingua

MC IVOR

037-160-010

Mundsperrer-Rahmen
Frame for Mouth Gag
Bastidor para abreboca
Telaio per apribocca

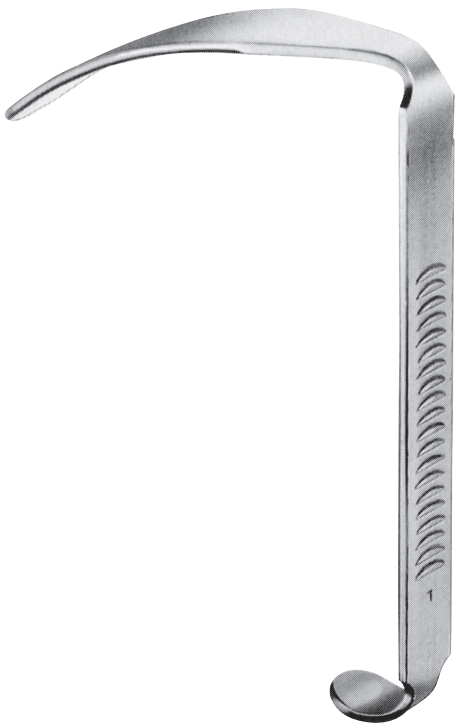

MC IVOR

037-160-001 13,5 cm / 5 1/2" 26 x 100 mm

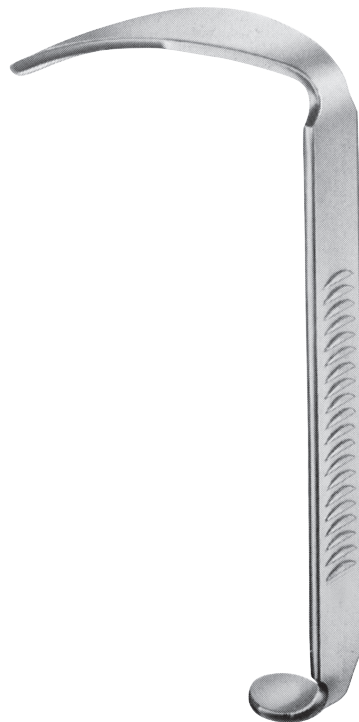

MC IVOR

037-160-002 13,5 cm / 5 1/2" 25 x 85 mm

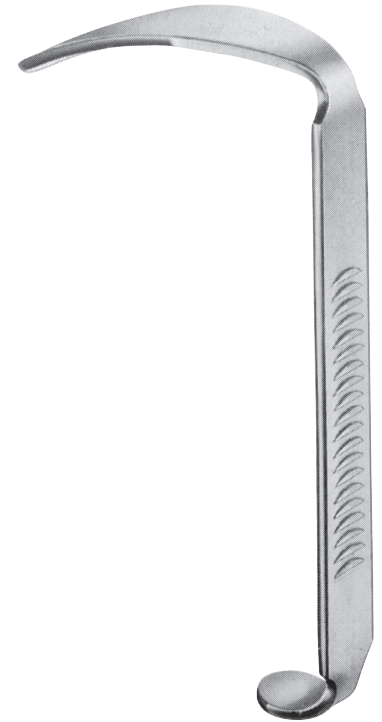

MC IVOR

037-160-003 13,5 cm / 5 1/2" 23 x 75 mm



DINGMANN

037-170-010

Mundsperrer-Rahmen
Frame for Mouth Gag
Bastidor para abreboca
Telaio per apribocca

DINGMANN

037-170-000

komplett mit Rahmen, 3 Zungenspateln und 2 beweglichen Seitenvalven
Complete with frame, 3 tongue depressors and 2 adjustable lateral blades
Completo con bastidor, 3 bajalenguas y 2 valvas laterales ajustables
completo con telaio, 3 abassalingua e 2 valve laterali mobili

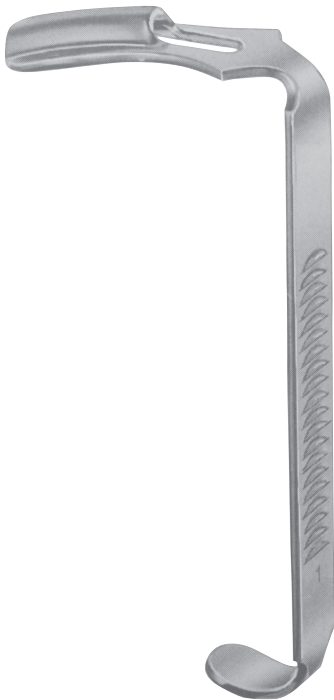

DINGMANN

037-170-001 13,5 cm / 5 1/2" 25 x 65 mm

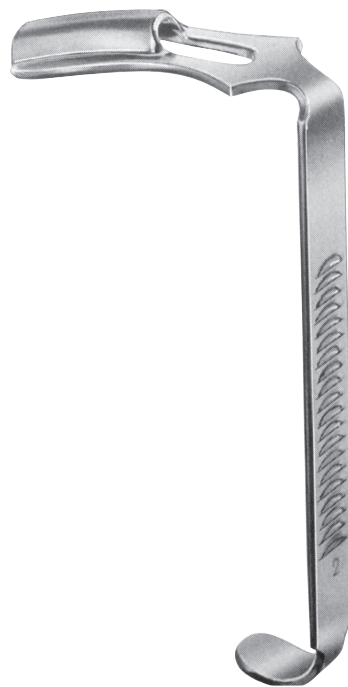

DINGMANN

037-170-002 13,5 cm / 5 1/2" 29 x 70 mm



DINGMANN

037-170-003 13,5 cm / 5 1/2" 32 x 80 mm



037

Mundsperrer
Mouth Gags
Abrebocas
Apribocca

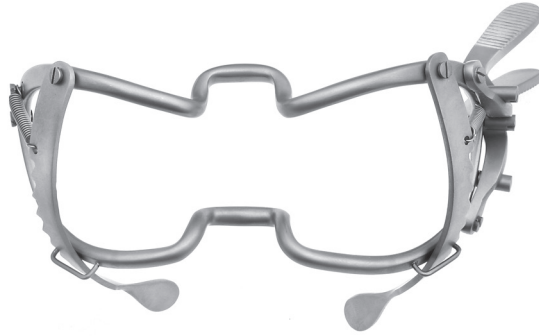

WHITEHEAD

037-173-110	11,0 cm / 4 ¹ / ₄ "
037-173-130	13,0 cm / 5"
037-173-150	15,0 cm / 6"

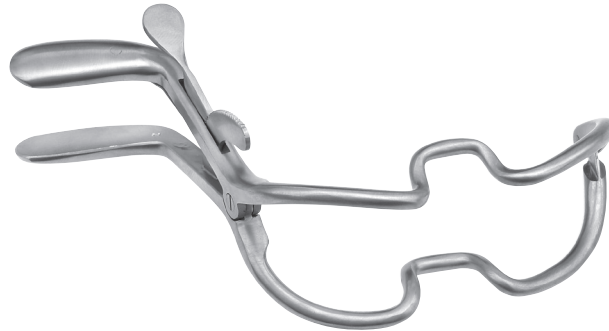

JENNINGS

037-175-090	9,0 cm / 3 ¹ / ₂ "
037-175-110	11,0 cm / 4 ¹ / ₄ "
037-175-130	13,0 cm / 5"
037-175-150	15,0 cm / 6"



SIMPLEX

037-183-110 11,0 cm / 4¹/₂"



STERNBERG

037-185-120 12,0 cm / 4³/₄"
037-185-140 14,0 cm / 5¹/₂"
037-185-160 16,0 cm / 6¹/₄"



037-187-190 19,0 cm / 7¹/₂"



CAWOOD-MINNESOTA

037-191-155 15,5 cm / 6"



037

Wangen- und Lippenhalter, Zungendrücker
 Cheek and Lip Retractors, Tongue Depressors
 Separadores para mejillas y labios, Abajalenguas
 Divaricatori per guanci e labbra, Abbassalingua

83x25 mm

80x25 mm



HARTMANN
037-193-150 15,0 cm / 6"



TOBOLD
037-195-145 14,5 cm / 5 1/2"



TOBOLD
037-197-145 14,5 cm / 5 1/2"

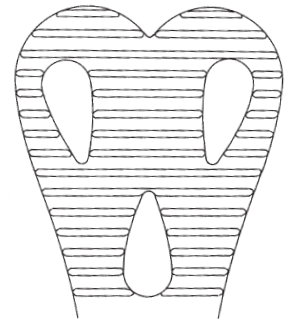

037-201-001 14,0 cm / 5 1/2"

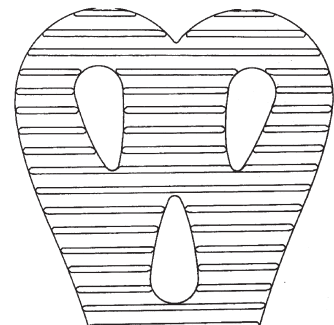

037-201-002 15,0 cm / 6"



ANDREW
037-199-110 11,0 cm / 4 3/8"



WIEDER
037-201-001 - 037-201-002



BUCHWALD

037-215-170 17,0 cm / 6³/₄"

037-215-190 19,0 cm / 7¹/₂"



BRUENINGS

037-217-190 19,0 cm / 7¹/₂"



037-219-145 14,5 cm / 5³/₄"



037

Zungenzangen
Tongue Holding Forceps
Pinzas tira-lengua
Pinze per lingua



COLLIN

037-220-160 16,0 cm / 6¹/₄"
037-220-180 18,0 cm / 7"



YOUNG

037-223-160 16,0 cm / 6¹/₄"



037-224-002

Gummibacken, allein (Paar)
Rubber inserts, only (pair)
Bocas de goma, sueltas (par)
Cuscino di gomma, soli (paio)



OBWEGESER

037-251-040 - 037-251-080 22,0 cm / 8³/₄"

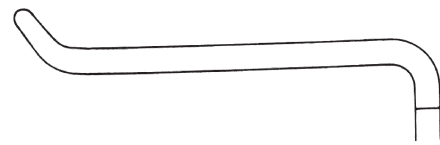

037-251-040 11 x 40 mm

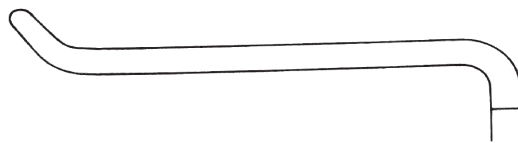

037-251-055 11 x 55 mm

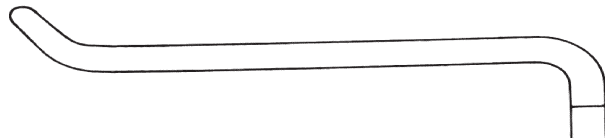

037-251-080 16 x 80 mm



037

Ramushaken
Ramus Retractors
Separadores para el ramo
Separatore per ramo

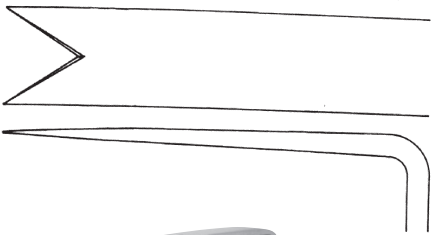

OBWEGESER

037-253-220 22,0 cm / 8³/₄" 10 x 45 mm

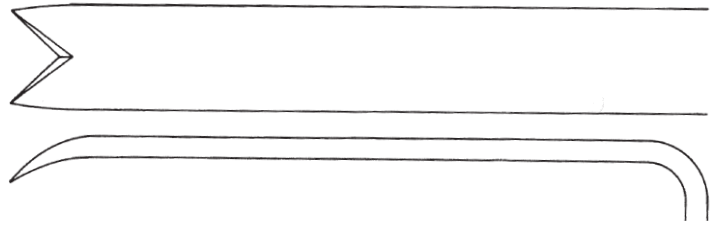

OBWEGESER

037-255-220 22,0 cm / 8³/₄" 11 x 70 mm



OBWEGESER

037-257-160 16,0 cm / 6¹/₂"



OBWEGESER

037-259-008 17,0 cm / 6³/₄" 8 mm
037-259-010 17,0 cm / 6³/₄" 10 mm



037

Raspatorien
Periosteal Elevators
Legras
Elevatori periosteo



037-265-006 6 mm



037-265-007 7 mm



037-265-009 9 mm

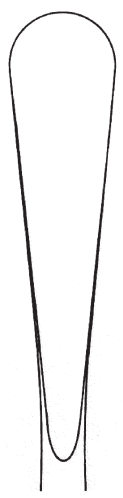

037-265-011 11 mm

OBWEGESER

037-265-006 - 037-265-011 17,5 cm / 7¹/₄"



037-267-005 5 mm



037-267-007 7 mm

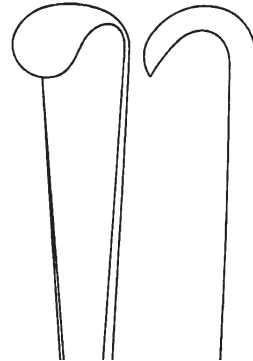

037-267-009 9 mm

OBWEGESER

037-267-005 - 037-267-009 20,0 cm / 8"

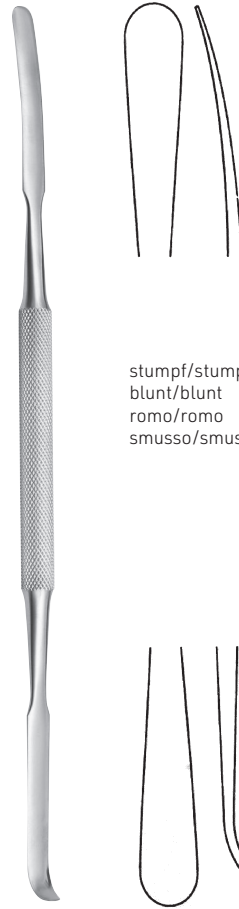

Fig. 1
037-269-001



Fig. 2
037-269-002

OBWEGESER
037-269-001 - 037-269-002 17,5 cm / 7"



stumpf/stumpf
 blunt/blunt
 romo/romo
 smusso/smusso



scharf/stumpf
 sharp/blunt
 agudo/romo
 acuto/smusso

OBWEGESER Fig. 1
037-271-210 21,0 cm / 8 1/2"

OBWEGESER Fig. 2
037-273-210 21,0 cm / 8 1/2"



037-276-025 2,5 mm



037-276-040 4,0 mm



037-276-065 6,5 mm

OBWEGESER
037-276-025 - 037-276-065 15,0 cm / 6"



037

Raspatorien, Osteotome, Ahlen
Raspatories, Osteotomes, Awls
Legras, Osteótomos, Leznas
Periostotomi, Osteotomi, Lesine

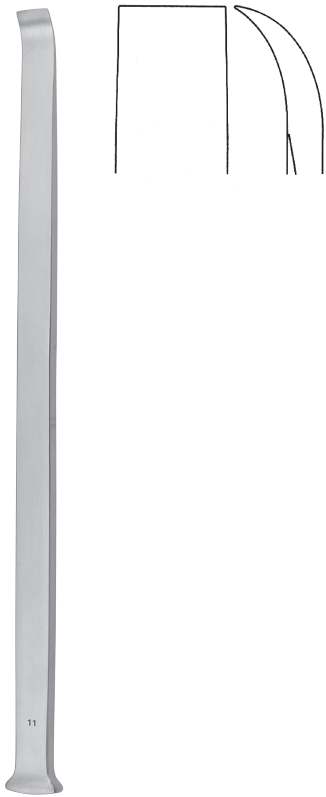

OBWEGESER

037-279-235 23,5 cm / 9 1/4"



OBWEGESER

037-281-185 - 037-283-185 18,5 cm / 7 1/4"



037-281-185



037-283-185



OBWEGESER

037-291-180 18,0 cm / 7"



OBWEGESER

037-293-140 14,0 cm / 5 1/2"



OBWEGESER

037-295-230 23,0 cm / 9"



Unterkiefer Ahle
Awl for lower jaw
Lezha para maxilar inferior
Lesina per mascella inferiore

KELSEY-FRY

037-297-150 15,0 cm / 6"



Oberkiefer Ahle
Awl for upper jaw
Lezna para maxilar superior
Lesina per mascella superiore

KELSEY-FRY

037-299-180 18,0 cm / 7¹/₄"



037

Repositionszangen
Reposition Forceps
Pinzas para reposición
Pinze per riposizione



links
left
izquierda
sinistra

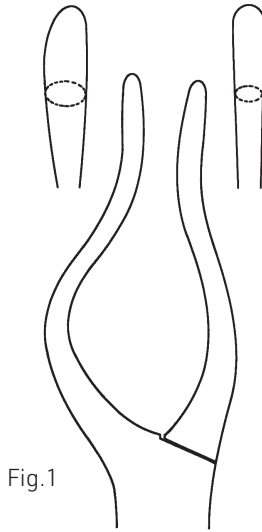

Fig.1

für Babys
for babies
para bebés
per neonati

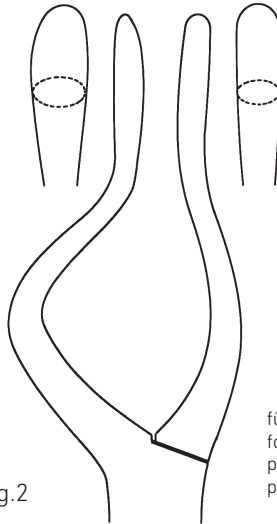

Fig.2

für Kinder
for children
para niños
per bambini

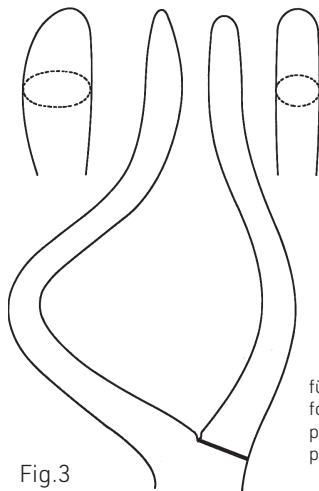

Fig.3

für Erwachsene
for adults
para adultos
per adulti



rechts
right
derecha
destra

ROWE

ROWE

037-301-001	Fig. 1	22,5 cm
037-301-002	Fig. 2	23,5 cm
037-301-003	Fig. 3	24,0 cm

037-303-001	Fig. 1	22,5 cm
037-303-002	Fig. 2	23,5 cm
037-303-003	Fig. 1	24,0 cm

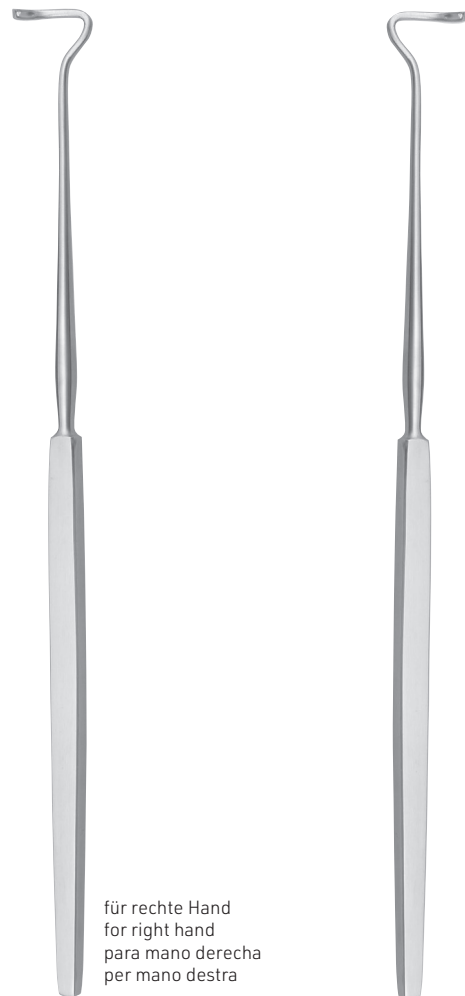
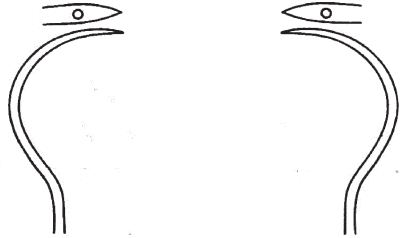

für rechte Hand
 for right hand
 para mano derecha
 per mano destra

für linke Hand
 for left hand
 para mano izquierda
 per mano sinistra

für rechte Hand
 for right hand
 para mano derecha
 per mano destra

für linke Hand
 for left hand
 para mano izquierda
 per mano sinistra

HURD

037-321-210 21,0 cm / 8¹/₄"

HURD

037-323-210 21,0 cm / 8¹/₄"

DUPUY WEISS

037-325-220 22,0 cm / 8³/₄"

DUPUY WEISS

037-327-220 22,0 cm / 8³/₄"



037

Tonsillennmesser
Tonsil Knives
Cuchillos para amígdalas
Bisturi per tonsille



FISCHER

037-345-225 22,5 cm / 9"



ABRAHAM

037-347-210 21,0 cm / 8¹/₄"



BRUENINGS

037-349-230 23,0 cm / 9"



CARPENTER

037-355-250 25,0 cm / 10"



CARPENTER

037-357-240 24,0 cm / 9 1/2"



HURD

037-359-225 22,5 cm / 9"



037

Tonsillendissektoren
Tonsil Dissectors
Disector para amígdalas
Disettori per tonsille

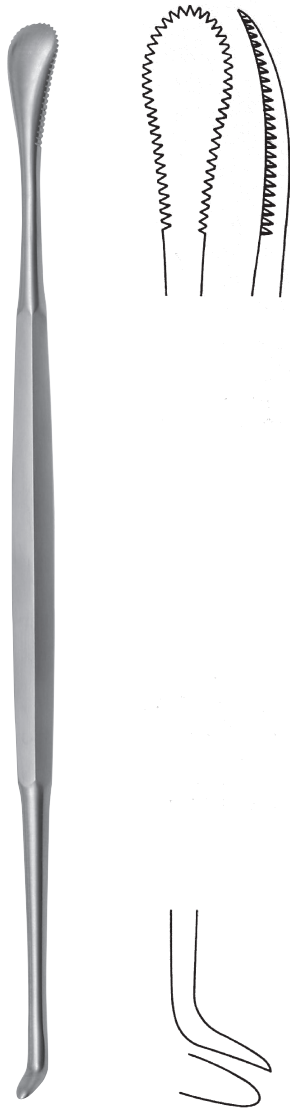

HENKE
037-361-230 23,0 cm / 9"

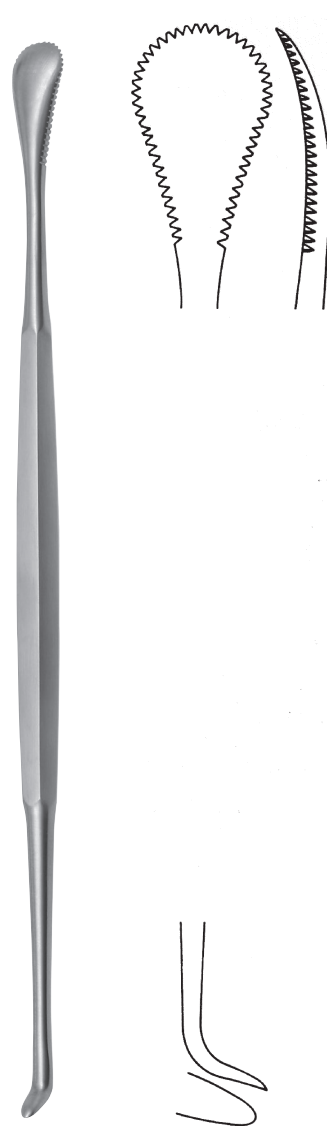

HENKE
037-363-230 23,0 cm / 9"

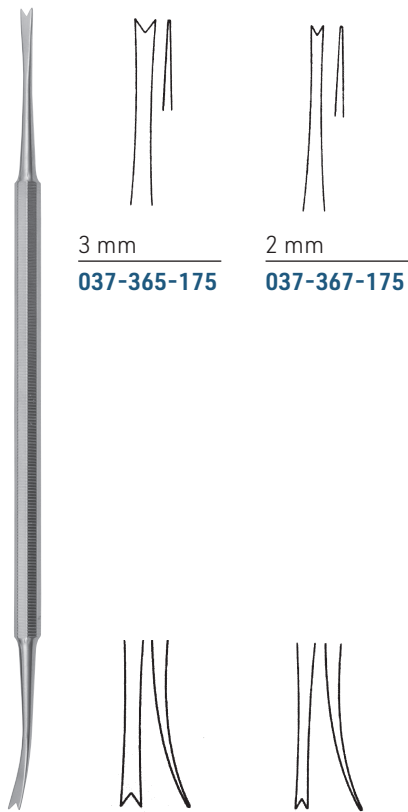

LUNIATSCHEK

037-365-175 - 037-367-175

17,5 cm / 6³/₄"

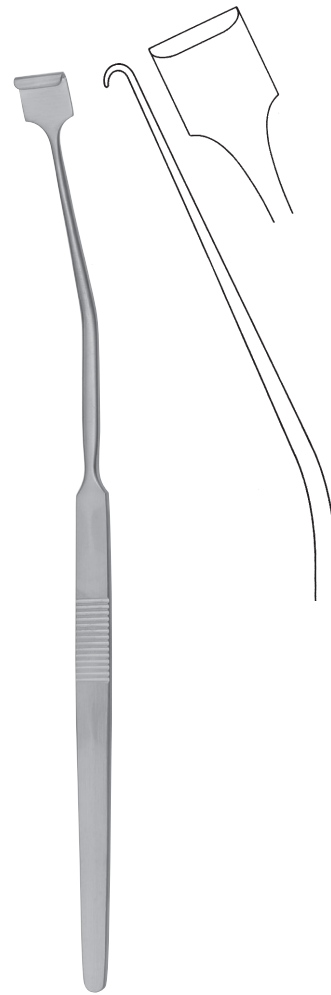

NAGER

037-369-240 24,0 cm / 9"



037

Tonsillenzangen
Tonsil Forceps
Pinzas para amígdalas
Pinze per tonsille

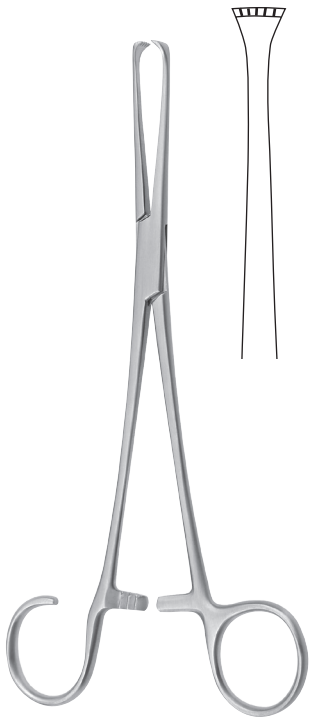

WHITE (COLVER)

037-378-190 19,0 cm / 7½"



WHITE (COLVER)

037-379-180 18,0 cm / 7"

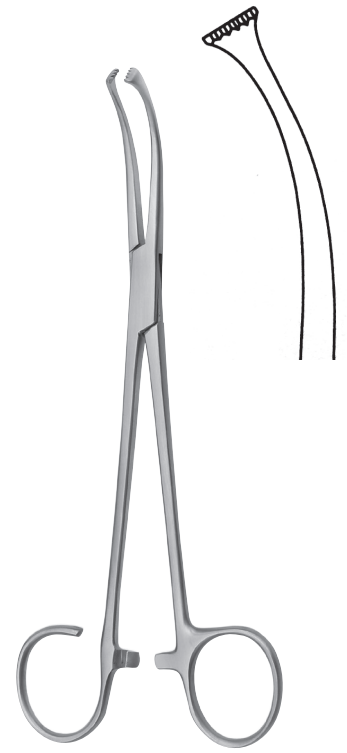

WHITE

037-381-180 18,0 cm / 7"
037-381-230 23,0 cm / 9"



BLOHMKE

037-383-200 20,0 cm / 8"

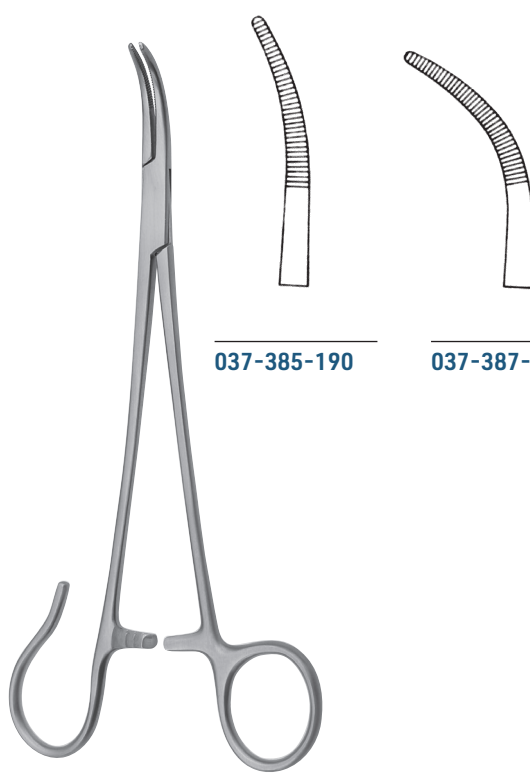

037-385-190

037-387-190

SCHNIDT

037-385-190 - 037-387-190 19,0 cm / 7½"

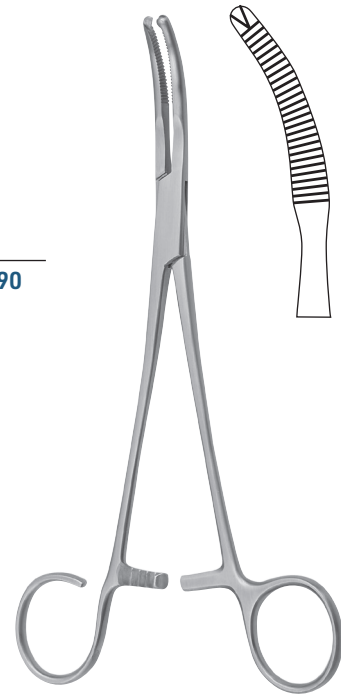

MIKULICZ

037-389-185 18,5 cm / 7¼"



Packung à 100 Stk.
 package with 100 pcs.
 paquete de 100 piezas
 confezione di 100 pezzi



Bündel mit 12 Stk.
 bundle with 12 pcs.
 manjo de 12 piezas
 manello di 12 pezzi

037-400-040 40 mm
037-400-050 50 mm

037-401-035 Ø 0,35 mm
037-401-040 Ø 0,40 mm
037-401-045 Ø 0,45 mm
037-401-050 Ø 0,50 mm



EVES

037-410-280 28,0 cm / 11"



EVES

037-412-280 28,0 cm / 11"



BRUENINGS

037-414-280 28,0 cm / 11"



RÖDER

037-416-265 26,5 cm / 10 1/2"

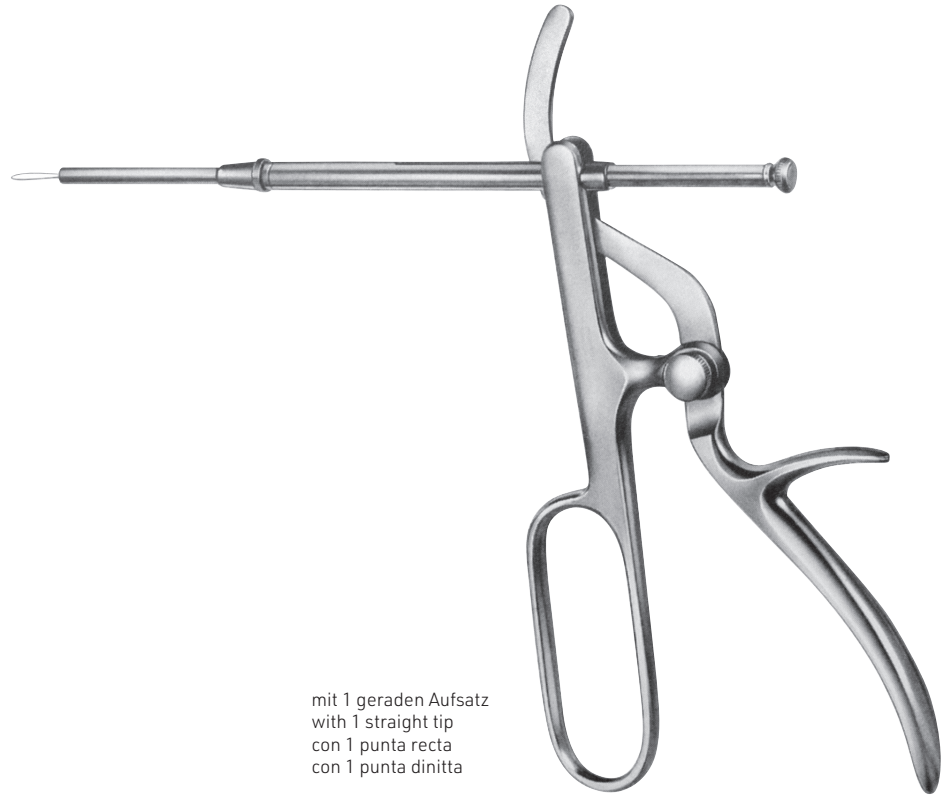

mit 1 geraden Aufsatz
with 1 straight tip
con 1 punta recta
con 1 punta dritta

TYDING
037-420-001

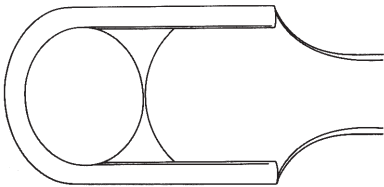

SLUDDER-BALLENGER
037-431-001 Fig.1

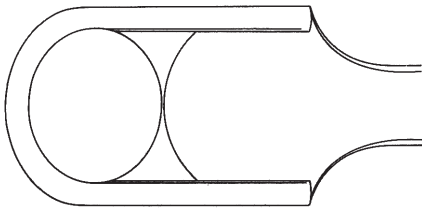

SLUDDER-BALLENGER
037-431-002 Fig.2

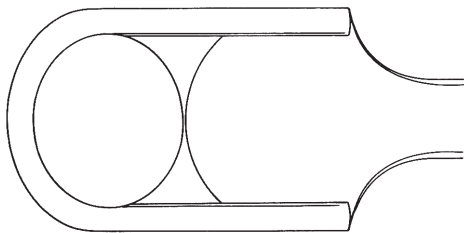

SLUDDER-BALLENGER
037-431-003 Fig.3



SLUDDER-BALLENGER
037-430-010

Griff alleine
handle only
mango suelto
manico solo

SLUDDER-BALLENGER
037-430-003

komplett mit 3 Aufsätzen
complete with 3 tips
completo con 3 puntas
completo con 3 punti



HARTMANN

037-435-013 - 037-435-017

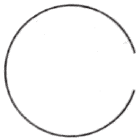

037-435-013 Ø 13 mm

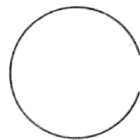

037-435-015 Ø 15 mm

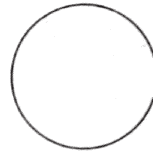

037-435-017 Ø 17 mm



CHEVALIER-JACKSON
037-440-300 - 037-446-600



Fig. 1

037-440-300	30,0 cm
037-440-400	40,0 cm
037-440-500	50,0 cm
037-440-600	60,0 cm



Fig. 2

037-441-300	30,0 cm
037-441-400	40,0 cm
037-441-500	50,0 cm
037-441-600	60,0 cm



Fig. 3

037-442-300	30,0 cm
037-442-400	40,0 cm
037-442-500	50,0 cm
037-442-600	60,0 cm



Fig. 4

037-443-300	30,0 cm
037-443-400	40,0 cm
037-443-500	50,0 cm
037-443-600	60,0 cm



Fig. 5

037-444-300	30,0 cm
037-444-400	40,0 cm
037-444-500	50,0 cm
037-444-600	60,0 cm



Fig. 6

037-445-300	30,0 cm
037-445-400	40,0 cm
037-445-500	50,0 cm
037-445-600	60,0 cm



Fig. 7

037-446-300	30,0 cm
037-446-400	40,0 cm
037-446-500	50,0 cm
037-446-600	60,0 cm



HUBER
037-450-001

Universal-Griff
 Universal Handle
 Mango universal
 Manico universale



BRUENINGS

037-452-200	20,0 cm / 8"
037-452-300	30,0 cm / 12"
037-452-400	40,0 cm / 16"

Verlängerungsrohr für Handgriff Art.-Nr. 037-450-001
 Interchangeable Tube for handle ref. 037-450-001
 Tubo de extensión para mango ref. 037-450-001
 Tube allunghi per manico rif..037-450-001

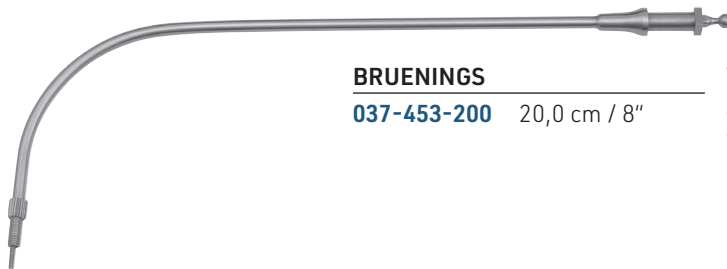

BRUENINGS

037-453-200	20,0 cm / 8"
--------------------	--------------

Verlängerungsrohr gebogen für Handgriff Art.-Nr. 037-450-001
 Interchangeable Tube, curved for handle ref. 037-450-001
 Tubo de extensión, curva para mango ref. 037-450-001
 Tube allunghi, curva per manico rif..037-450-001



FRAENKEL
 037-456-001



SEIFFERT
 037-458-001



FRAENKEL
 037-460-001



SCHEINMANN
 037-461-001



SCHEINMANN
 037-463-001



BRUENINGS
 037-464-003
 037-464-004



BRUENINGS
 037-466-002
 037-466-003



LANGE
 037-468-001







KRAUSE
 037-470-001
 037-470-002



KRAUSE
 037-472-001



CORDES
 037-474-001
 037-474-002
 037-474-003
 037-474-004



SCHUMACHER
 037-476-001



CORDES
 037-478-001
 037-478-002



CORDES
 037-480-001



ROSENBERG
 037-482-001



037

Kehlkopfpolypenzange, Deckenhalter
Laryngeal Polypus Forceps, Epiglottis Retractor
Pinza para pólipos laringeos, Depresor para epíglotis
Pinze per polipi laringei, Depressore per epiglottide



037-485-001

nach rechts öffnend
opening to right side
abriendo hacia la derecha
aprente verso
destra



037-485-002

nach links öffnend
opening to left side
abriendo hacia la izquierda
aprente verso sinistra



037-485-003

nach unten öffnend
opening down-ward
abriendo hacia abajo
aprente in basso

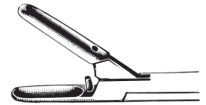

037-485-004

nach oben öffnend
opening up-ward
abriendo hacia arriba
aprente in alto

JURASZ

037-485-001 - 037-485-004 23,0 cm / 9"



REICHERT

037-487-240 24,0 cm / 9 1/2"

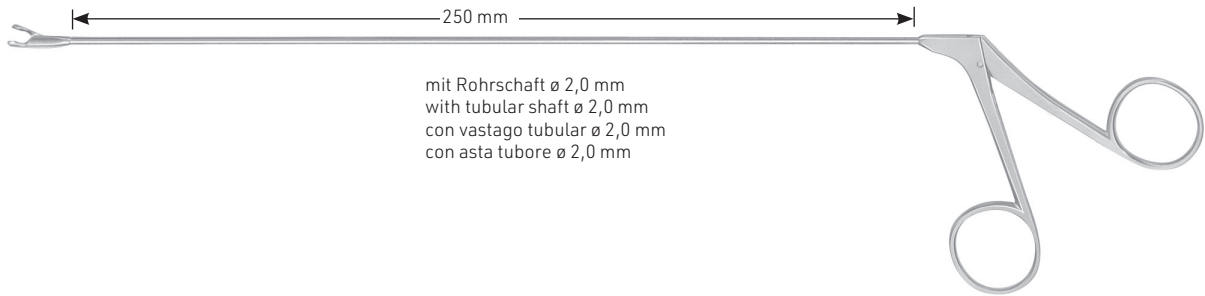

037-490-001 - 037-494-004



gerade
 straight
 recta
 retta

037-490-001

Löffel rund ø 2,5 mm
 round cup ø 2,5 mm
 Cuchara redonda ø 2,5 mm
 Cucchiaio rotondo ø 2,5 mm



links gebogen
 curved left
 curva izquierda
 curva sinistra

037-490-002

Löffel rund ø 2,5 mm
 round cup ø 2,5 mm
 Cuchara redonda ø 2,5 mm
 Cucchiaio rotondo ø 2,5 mm



rechts gebogen
 curved right
 curva derecha
 curva destra

037-490-003

Löffel rund ø 2,5 mm
 round cup ø 2,5 mm
 Cuchara redonda ø 2,5 mm
 Cucchiaio rotondo ø 2,5 mm



aufgebogen
 angled upward
 curva hacia arriba
 curva in alto

037-490-004

Löffel rund ø 2,5 mm
 round cup ø 2,5 mm
 Cuchara redonda ø 2,5 mm
 Cucchiaio rotondo ø 2,5 mm



gerade
 straight
 recta
 retta

037-492-001



links gebogen
 curved left
 curva izquierda
 curva sinistra

037-492-002



rechts gebogen
 curved right
 curva derecha
 curva destra

037-492-003



gerade
 straight
 recta
 retta

037-494-001



links gebogen
 curved left
 curva izquierda
 curva sinistra

037-494-002



rechts gebogen
 curved right
 curva derecha
 curva destra

037-494-003



aufgebogen
 angled upward
 curva hacia arriba
 curva in alto

037-494-004



037

Kehlkopfspiegel, Spiegelgriffe
 Laryngeal Mirrors, Mirror Handles
 Espejos laringeales, Mangos para espejos
 Specchi laringei, Manico per specchi



mit festem Handgriff
 with fixed handle
 con mango fijo
 con manico fisso

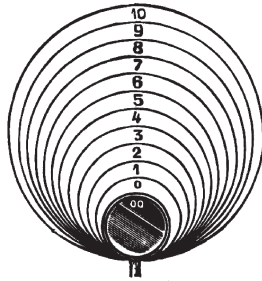

ohne Handgriff
 without handle
 sin mango
 senza manico



MICHEL

25,0 cm / 10"

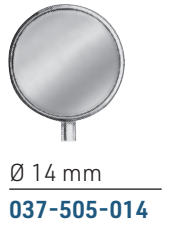

- 037-501-008**
- 037-501-010**
- 037-501-012**
- 037-501-014**
- 037-501-016**
- 037-501-018**
- 037-501-020**
- 037-501-022**
- 037-501-024**
- 037-501-026**
- 037-501-028**
- 037-501-030**

- Fig. 00 = 8 mm Ø
- Fig. 0 = 10 mm Ø
- Fig. 1 = 12 mm Ø
- Fig. 2 = 10 mm Ø
- Fig. 3 = 16 mm Ø
- Fig. 4 = 18 mm Ø
- Fig. 5 = 20 mm Ø
- Fig. 6 = 22 mm Ø
- Fig. 7 = 24 mm Ø
- Fig. 8 = 26 mm Ø
- Fig. 9 = 28 mm Ø
- Fig. 10 = 30 mm Ø

- 037-503-008**
- 037-503-010**
- 037-503-012**
- 037-503-014**
- 037-503-016**
- 037-503-018**
- 037-503-020**
- 037-503-022**
- 037-503-024**
- 037-503-026**
- 037-503-028**
- 037-503-030**



037-506-100 10,0 cm



037-510-120 12,0 cm

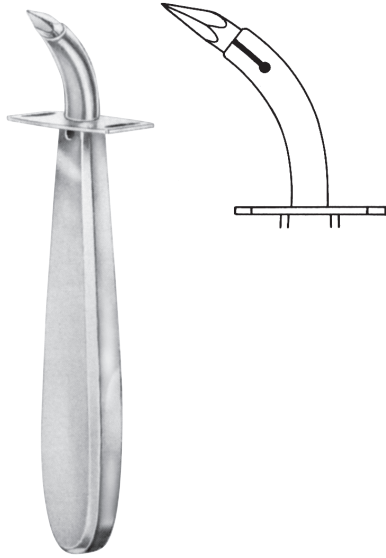

UECKERMANN
 13,0 cm / 5"

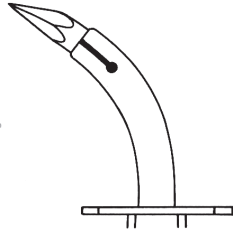

037-601-075 Ø 7,5 mm



037-601-090 Ø 9 mm



LABORDE
037-605-140 14,0 cm / 5½"



TROUSSEAU
037-609-120 12,0 cm / 4¾"
037-609-140 14,0 cm / 5½"



037

Tracheal-Häkchen
Tracheal Hooks
Ganchos traqueales
Uncini tracheali



ITERSON

17,0 cm / 6 1/4"



spitz
sharp
agudo
acuto

037-621-170



stumpf
blunt
romo
smusso

037-623-170



links
left
izquierda
sinistra

BOSE

037-625-160 16,0 cm / 6 1/4"

scharf
sharp
agudo
acuto

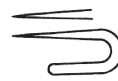

rechts
right
derecha
destra

BOSE

037-627-160 16,0 cm / 6 1/4"



ROSE

037-629-135 13,5 cm / 5"

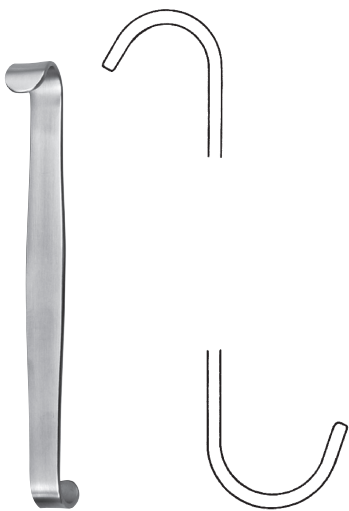

LUER

037-631-110 11,0 cm / 4 1/2"

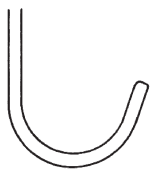
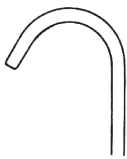

JACKSON

037-635-150 15,0 cm / 6"

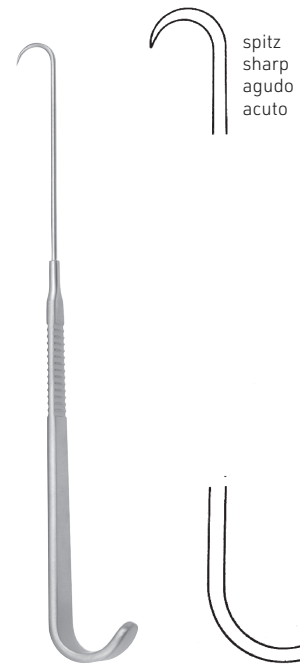

spitz
sharp
agudo
acuto

037-637-150

15,0 cm / 6"

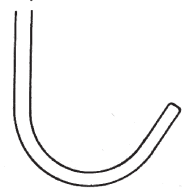

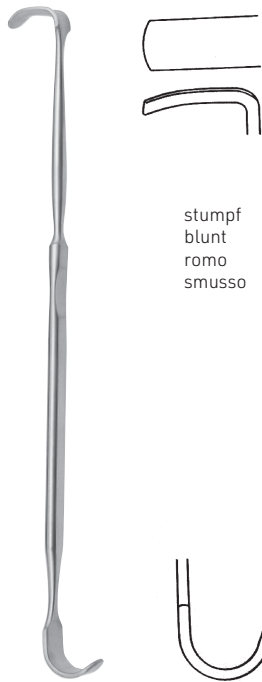

stumpf
blunt
romo
smusso

LUKENS

037-641-170 17,0 cm / 6³/₄"

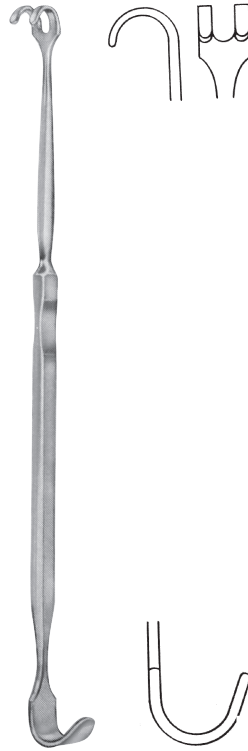

JACKSON

037-643-170 17,0 cm / 6³/₄"

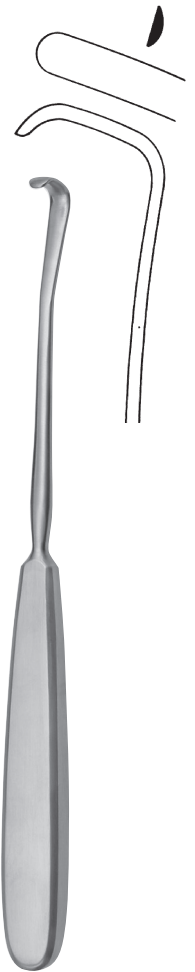

SCHOENBORN

037-645-210 21,0 cm / 8¹/₄"



037

Tracheal-Kanülen
Tracheal Tubes
Cánulas traqueales
Cannule tracheali

Material: Edelstahl
Material: Stainless Steel
Material: acero inoxidable
Materiale: acciaio inossidabile

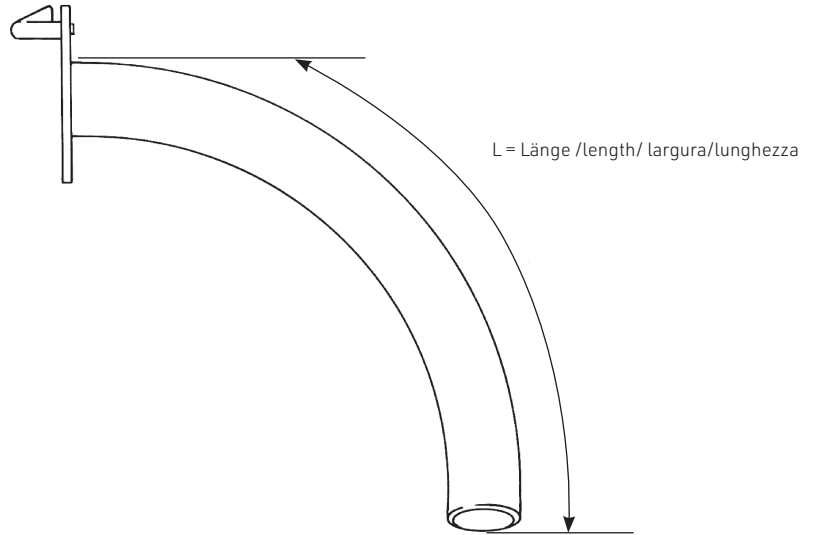

LUER		L	
037-701-004	Fig. 0	Ø 4 mm	45 mm
037-701-005	Fig. 1	Ø 5 mm	50 mm
037-701-006	Fig. 2	Ø 6 mm	55 mm
037-701-007	Fig. 3	Ø 7 mm	60 mm
037-701-008	Fig. 4	Ø 8 mm	65 mm
037-701-009	Fig. 5	Ø 9 mm	70 mm
037-701-010	Fig. 6	Ø 10 mm	75 mm
037-701-011	Fig. 7	Ø 11 mm	80 mm
037-701-012	Fig. 8	Ø 12 mm	85 mm
037-701-013	Fig. 9	Ø 13 mm	90 mm



CHEVALIER-JACKSON		L	
037-711-004	Fig. 0	Ø 4 mm	45 mm
037-711-005	Fig. 1	Ø 5 mm	50 mm
037-711-006	Fig. 2	Ø 6 mm	55 mm
037-711-007	Fig. 3	Ø 7 mm	60 mm
037-711-008	Fig. 4	Ø 8 mm	65 mm
037-711-009	Fig. 5	Ø 9 mm	70 mm
037-711-010	Fig. 6	Ø 10 mm	75 mm
037-711-011	Fig. 7	Ø 11 mm	80 mm
037-711-012	Fig. 8	Ø 12 mm	85 mm
037-711-013	Fig. 9	Ø 13 mm	90 mm



037-851-150

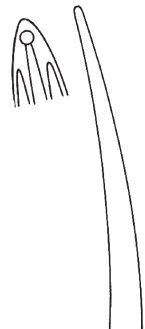

037-853-150

KOCHER

037-851-150 - 037-853-150 15,0 cm / 6"

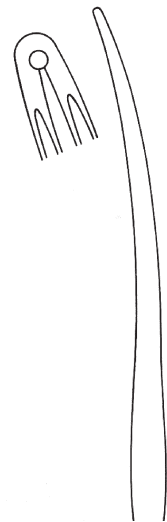

KOCHER

037-855-180 18,0 cm / 7"



037

Kropffazangen, Klemme
Goitre Grasping Forceps, Clamps
Pinzas para coger el bocio, Clamp para musculos
Pinze per gozzo, Pinza

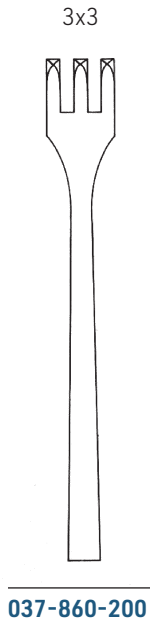
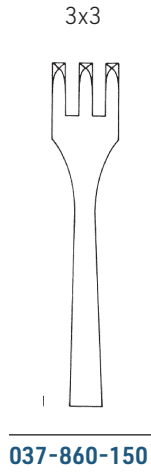

LAHEY

037-860-150 15,0 cm / 6"

037-860-200 20,0 cm / 8"

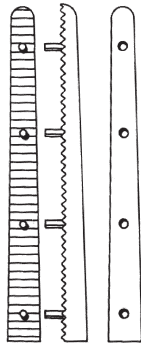

MASTIN

037-865-170 17,0 cm / 7"

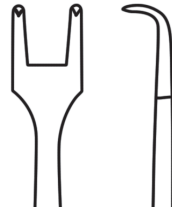
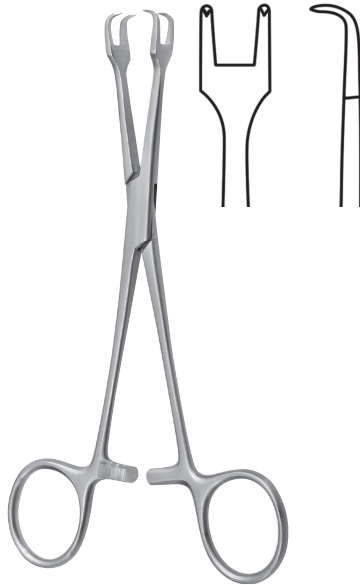

LAHEY

037-868-150 15,0 cm / 6"

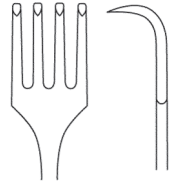

BRAUN

037-870-150 15,0 cm / 6"