



035

Rhinologie  
Rhinology  
Rinología  
Rinologia



035

Nasenspekula  
Nasal Specula  
Espèculos nasales  
Specoli nasali

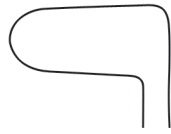

Fig.1  
**035-100-001** 21,0 x 9,5 mm

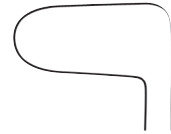

Fig.2  
**035-100-002** 21,0 x 10,5 mm



**GOLDSMITH (THUDICHUM)**  
**035-100-001 - 035-100-003** 6,5 cm / 2 1/2"

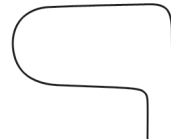

Fig.3  
**035-100-003** 21,0 x 11,5 mm



FIG. 1  
**035-110-001**

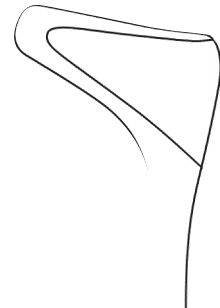

FIG. 2  
**035-110-002**



**HARTMANN-HALLE**  
**035-110-001 - 035-110-003** 15,0 cm / 6"

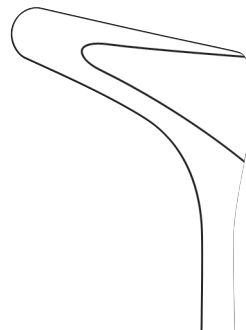

FIG. 3  
**035-110-003**

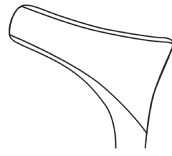

Fig.1  
**035-120-001**

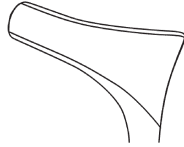

Fig.2  
**035-120-002**

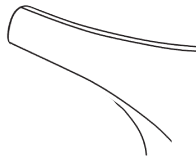

Fig.3  
**035-120-003**

**HARTMANN**

**035-120-001 - 035-120-003** 15,0 cm / 6"



Fig.1  
**035-130-001**

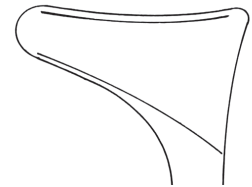

Fig.2

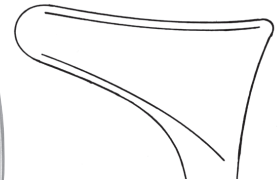
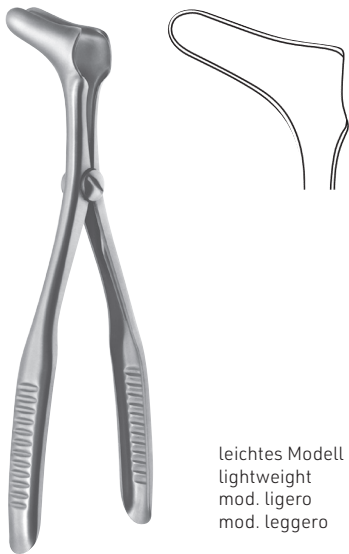

Fig.3  
**035-130-003**

**MOD. WIEN**

**035-130-001 - 035-130-003** 14,5 cm / 5 1/4"



leichtes Modell  
 lightweight  
 mod. ligero  
 mod. leggero

**MOD. WIEN**

**035-132-135** 13,5 cm / 5 1/4"



Fig.1  
**035-140-001**



Fig.2  
**035-140-002**

**TIECK-HALLE**

**035-140-001 - 035-140-002** 13,0 cm / 5 1/8"



035

Nasenspekula  
Nasal Specula  
Espèculos nasales  
Specoli nasali

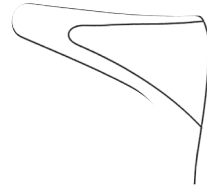

FIG. 1  
**035-150-001** 35 mm

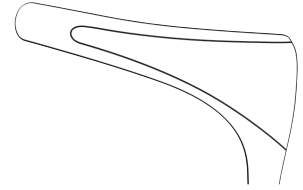

FIG. 2  
**035-150-002** 50 mm

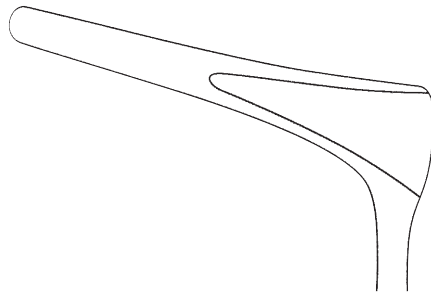

FIG. 3  
**035-150-003** 75 mm

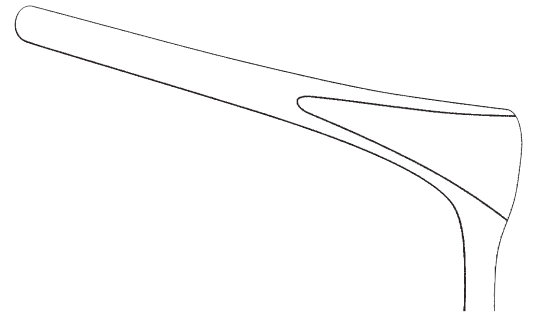

FIG. 4  
**035-150-004** 90 mm

**KILIAN**

**035-150-001 - 035-150-003** 13,0 cm / 5 1/8"

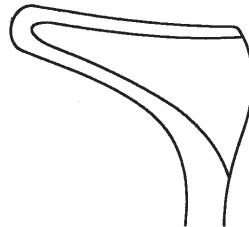

FIG. 1  
**035-160-001** 35 mm

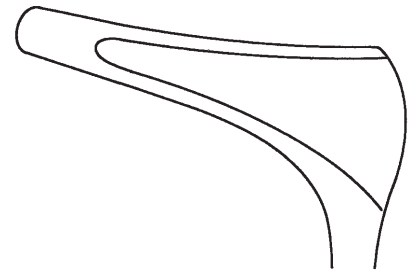

FIG. 2  
**035-160-002** 50 mm

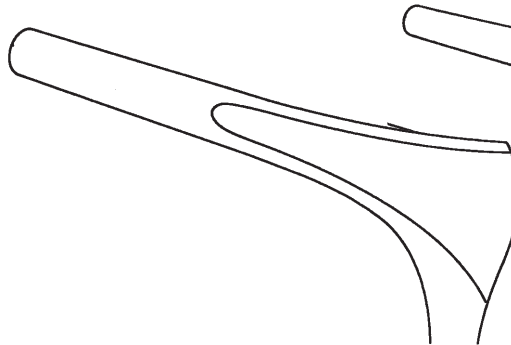

FIG. 3  
**035-160-003** 75 mm

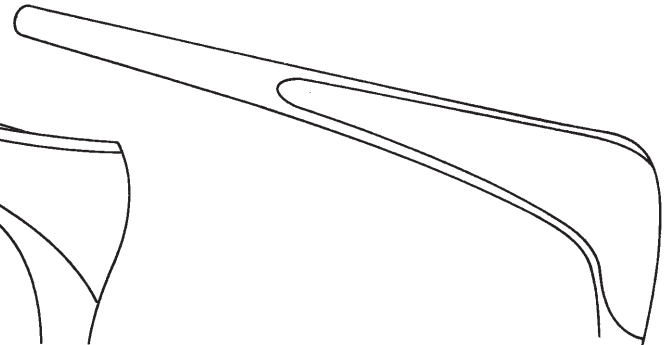

FIG. 4  
**035-160-004** 90 mm

**COTTLE**

**035-160-001 - 035-160-004** 13,5 cm / 5 1/4"



**BECKMANN** Fig.1  
**035-164-001** 13,0 cm / 5 1/8"



**BECKMANN** Fig.2  
**035-164-002** 14,0 cm / 5"



Schaft Ø 3 mm  
 Shaft Ø 3 mm  
 västago Ø 3mm  
 gambo Ø 3 mm

**KRAUSE**  
**035-171-260** 26,0 cm / 10 1/4"

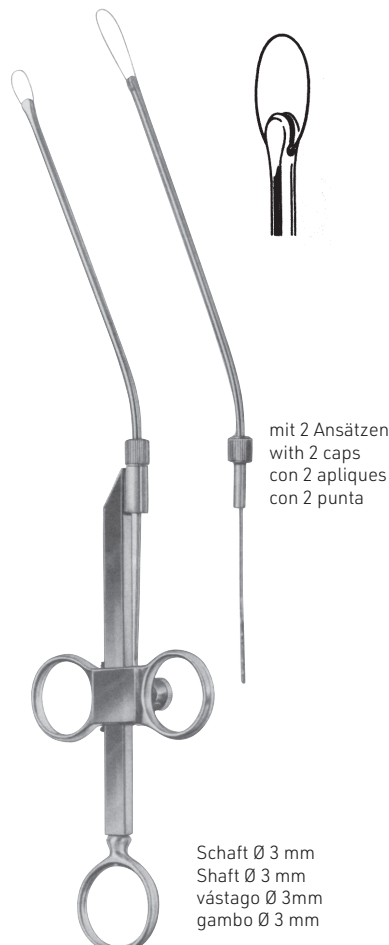

mit 2 Ansätzen  
 with 2 caps  
 con 2 appliques  
 con 2 punta

Schaft Ø 3 mm  
 Shaft Ø 3 mm  
 västago Ø 3mm  
 gambo Ø 3 mm

**KRAUSE-VOSS**  
**035-173-260** 26,0 cm / 10 1/4"

Schnürschlingen Ø 0,30 mm  
 Bündel mit 12 Stück  
 Snare loops Ø 0,30 mm  
 Bundle with 12 pieces  
 Asas de alambre Ø 0,30 mm  
 Manojos de 12 piezas  
 Lacci di filo di metallo Ø 0,30 mm  
 Manello di 12 pezzi



**035-175-003** 10,0 cm



035

Nasentamponpinzetten, Nasenpolypenzangen  
Nasal Tampon Forceps, Nasal Polypus Forceps  
Pinzas para taponamiento, Pinzas para pólipos nasales  
Pinze per medicature, Pinze per polipi nasali



**TRÖLTSCH**  
**035-181-150** 15,0 cm / 6"



**TRÖLTSCH**  
**035-181-180** 18,0 cm / 7"



**JANSEN (GRÜNWALD)**  
**035-185-180** 18,0 cm / 7"  
**035-185-200** 20,0 cm / 8"



**WESTMACOTT**  
**035-201-200** 20,0 cm / 8"

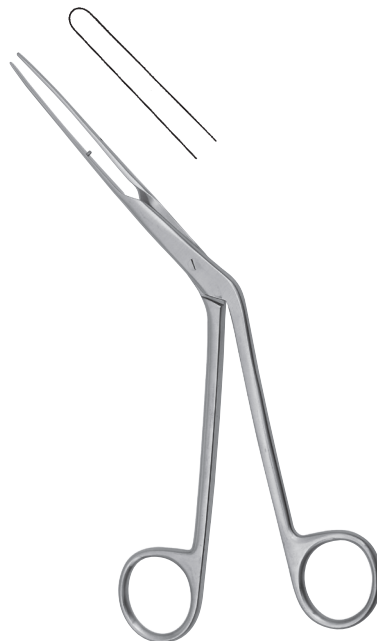

**LUBET-BARBON**  
**035-203-185** 18,5 cm / 7 1/4"



**HARTMANN**  
**035-205-160** 16,0 cm / 6 1/4"



**HARTMANN**  
**035-207-200** 20,0 cm / 8"

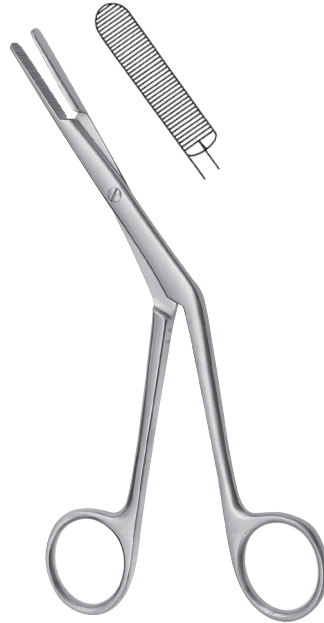

**KILLIAN**  
**035-209-170** 17,0 cm / 6<sup>3</sup>/<sub>4</sub>"



**HEYMANN**  
**035-221-180** 18,0 cm / 7"



**KNIGHT**  
**035-223-180** 18,0 cm / 7"



**CRAIG**  
**035-225-160** 16,0 cm / 6<sup>1</sup>/<sub>4</sub>"



**035-229-001**  
 links gebogen  
 left curved  
 curva por izquierda  
 curva a sinistra

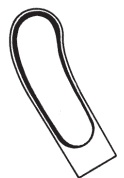

**035-229-002**  
 rechts gebogen  
 right curved  
 curva por derecha  
 curva a destra

**035-229-001 - 035-229-002** 16,0 cm / 6<sup>1</sup>/<sub>4</sub>"



035

Septumzangen, scharfe Nasenzangen  
 Septum Forceps, Nasal Cutting Forceps  
 Pinzas para tabique nasal, Pinzas nasales cortantes  
 Pinze per il setto nasale, Pinze nasale taglienti per il naso

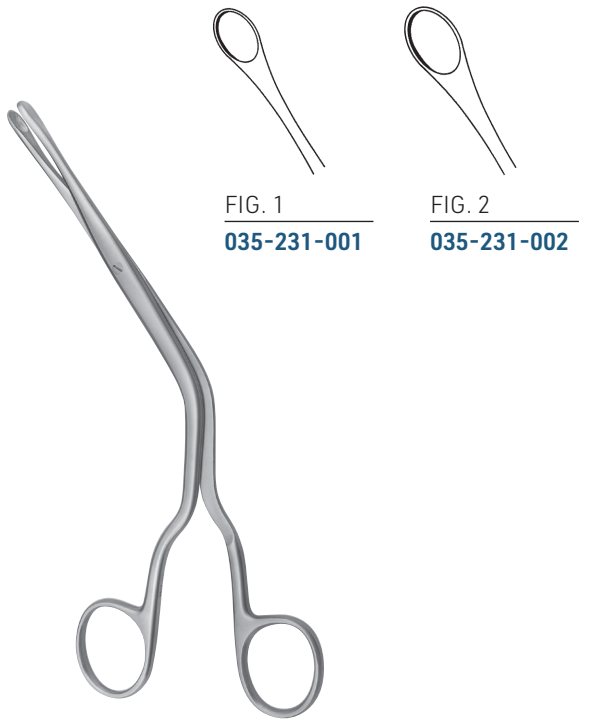

FIG. 1  
 035-231-001

FIG. 2  
 035-231-002

**LUC**  
 035-231-001 - 035-231-002      20,0 cm / 8"

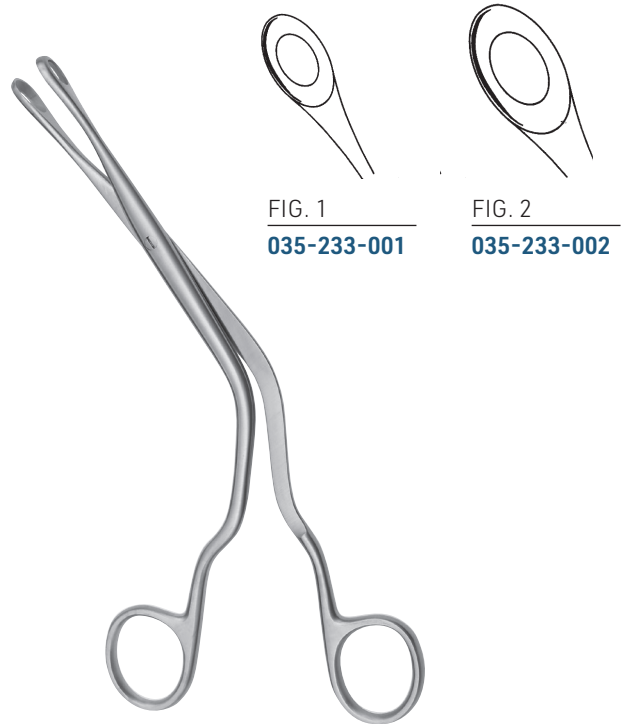

FIG. 1  
 035-233-001

FIG. 2  
 035-233-002

**LUC**  
 035-233-001 - 035-233-002      19,0 cm / 7 1/2"



FIG. 1  
 035-235-001

FIG. 2  
 035-235-002

FIG. 3  
 035-235-003

FIG. 4  
 035-235-004

**BRUENINGS**  
 035-235-001 - 035-235-004      19,0 cm / 7 1/2"



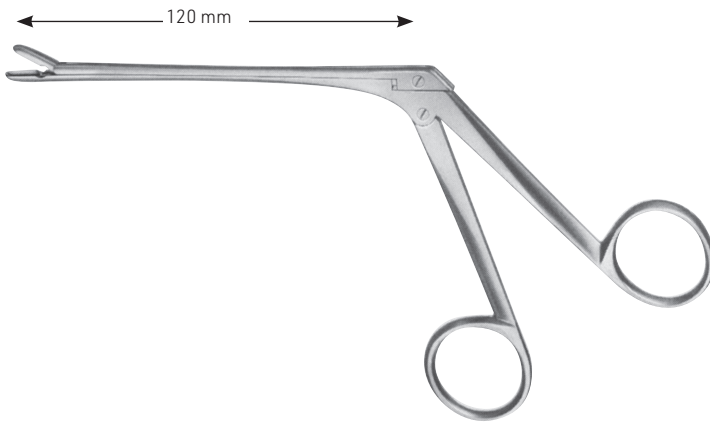

3 x 8 mm



**035-240-190**

gerade  
 straight  
 recto  
 retto

3 x 8 mm



**035-241-190**

aufgebogen  
 bent upwards  
 curva por arriba  
 curva in alto

**TAKAHASHI**

**035-240-190 - 035-241-190**

19,0 cm / 7 1/2"

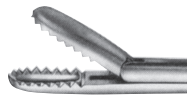
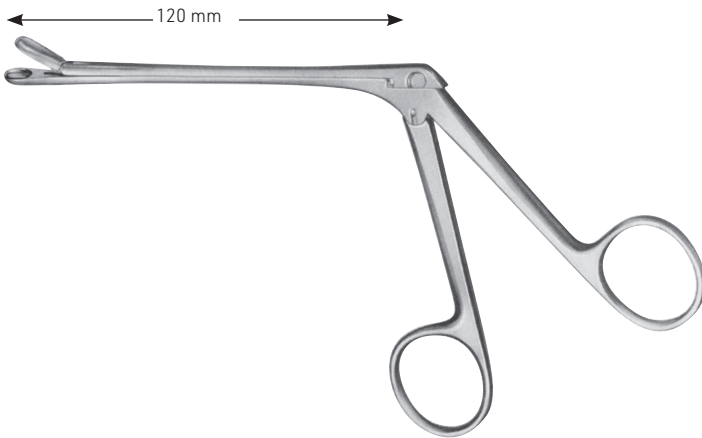

**WATSON-WILLIAMS**

**035-243-190**

gerade  
 straight  
 recto  
 retto



**035-245-190**

gerade  
 straight  
 recto  
 retto

**035-243-190 - 035-245-190**

19,0 cm / 7 1/2"

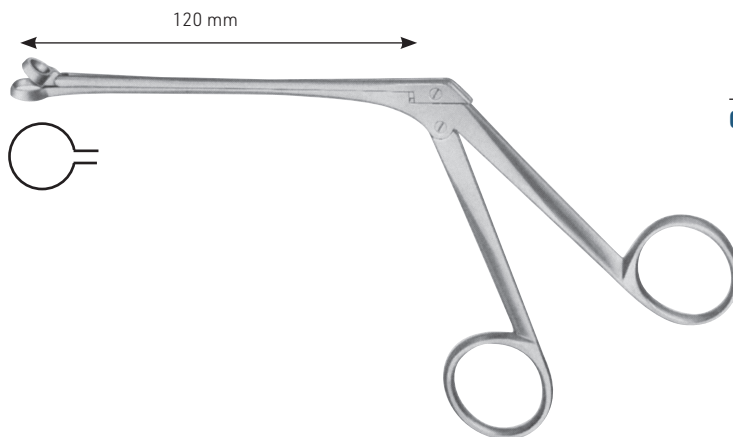

**035-251-005** Ø 5 mm



**035-251-007** Ø 7 mm



**035-251-009** Ø 9 mm



**035-251-011** Ø 11 mm

**HARTMANN**

**035-251-005 - 035-251-011**

19,0 cm / 7 1/2"

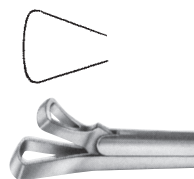

**SCHMEDEN**

**035-253-190** 19,0 cm / 7 1/2"

Maulbreite 8,0 mm  
 jaw width 8,0 mm  
 anchura de la boca 8,0 mm  
 larghezza della bocca 8,0 mm



035

Scharfe Nasenzangen  
Nasal Cutting Forceps  
Pinzas nasales cortantes  
Pinze taglienti per il naso

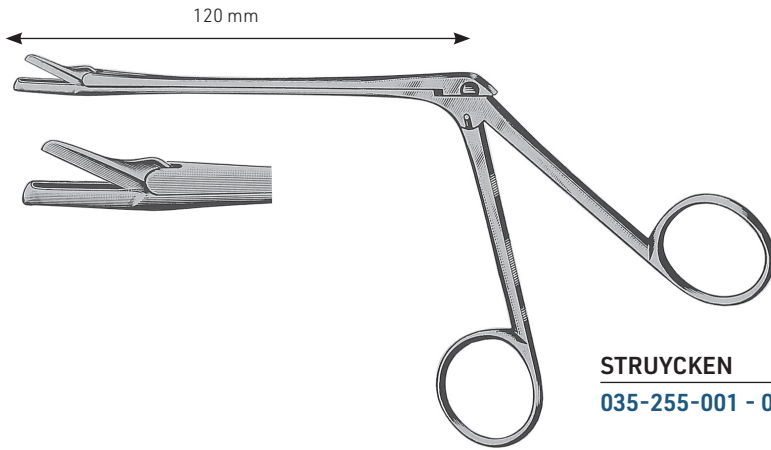

**STRUYCKEN**

**035-255-001 - 035-255-002**

19,0 cm / 7 1/2"

FIG. 1

**035-255-001**

Maulbreite 1,0 mm  
jaw width 1,0 mm  
anchura de la boca 1,0 mm  
larghezza della bocca 1,0 mm

FIG. 2

**035-255-002**

Maulbreite 1,5 mm  
jaw width 1,5 mm  
anchura de la boca 1,5 mm  
larghezza della bocca 1,5 mm

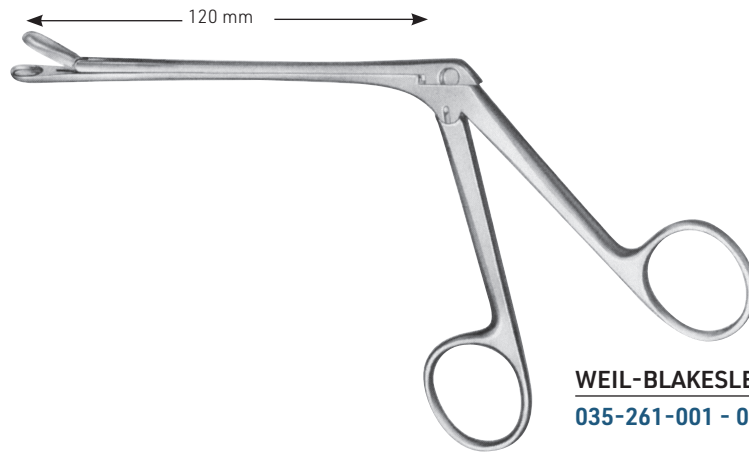

**WEIL-BLAKESLEY**

**035-261-001 - 035-262-005**

19,0 cm / 7 1/2"



FIG. 1

**035-261-001**

Maulbreite 3,0 mm  
jaw width 3,0 mm  
anchura de la boca 3,0 mm  
larghezza della bocca 3,0 mm

FIG. 2

**035-261-002**

Maulbreite 3,5 mm  
jaw width 3,5 mm  
anchura de la boca 3,5 mm  
larghezza della bocca 3,5 mm

FIG. 3

**035-261-003**

Maulbreite 4,5 mm  
jaw width 4,5 mm  
anchura de la boca 4,5 mm  
larghezza della bocca 4,5 mm

FIG. 4

**035-261-004**

Maulbreite 5,0 mm  
jaw width 5,0 mm  
anchura de la boca 5,0 mm  
larghezza della bocca 5,0 mm

FIG. 5

**035-261-005**

Maulbreite 5,5 mm  
jaw width 5,5 mm  
anchura de la boca 5,5 mm  
larghezza della bocca 5,5 mm



mit Hals  
with neck  
con cuello  
con collo

FIG. 1

**035-262-001**

Maulbreite 3,0 mm  
jaw width 3,0 mm  
anchura de la boca 3,0 mm  
larghezza della bocca 3,0 mm

FIG. 2

**035-262-002**

Maulbreite 3,5 mm  
jaw width 3,5 mm  
anchura de la boca 3,5 mm  
larghezza della bocca 3,5 mm

FIG. 3

**035-262-003**

Maulbreite 4,5 mm  
jaw width 4,5 mm  
anchura de la boca 4,5 mm  
larghezza della bocca 4,5 mm

FIG. 4

**035-262-004**

Maulbreite 5,0 mm  
jaw width 5,0 mm  
anchura de la boca 5,0 mm  
larghezza della bocca 5,0 mm

FIG. 5

**035-262-005**

Maulbreite 5,5 mm  
jaw width 5,5 mm  
anchura de la boca 5,5 mm  
larghezza della bocca 5,5 mm

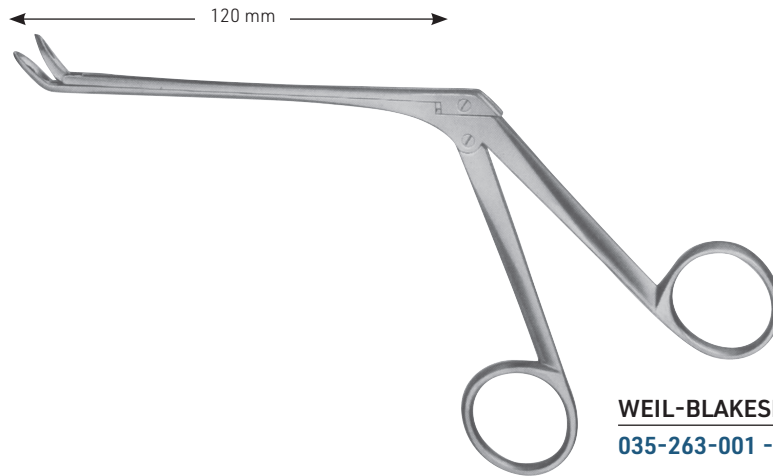

**WEIL-BLAKESLEY**

**035-263-001 - 035-263-004**

19,0 cm / 7 1/2"

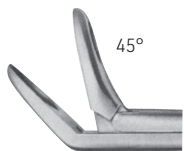

45°



FIG. 1

**035-263-001**

Maulbreite 3,0 mm  
 jaw width 3,0 mm  
 anchura de la boca 3,0 mm  
 larghezza della bocca 3,0 mm



FIG. 2

**035-263-002**

Maulbreite 3,5 mm  
 jaw width 3,5 mm  
 anchura de la boca 3,5 mm  
 larghezza della bocca 3,5 mm



FIG. 3

**035-263-003**

Maulbreite 4,5 mm  
 jaw width 4,5 mm  
 anchura de la boca 4,5 mm  
 larghezza della bocca 4,5 mm



FIG. 4

**035-263-004**

Maulbreite 5,0 mm  
 jaw width 5,0 mm  
 anchura de la boca 5,0 mm  
 larghezza della bocca 5,0 mm

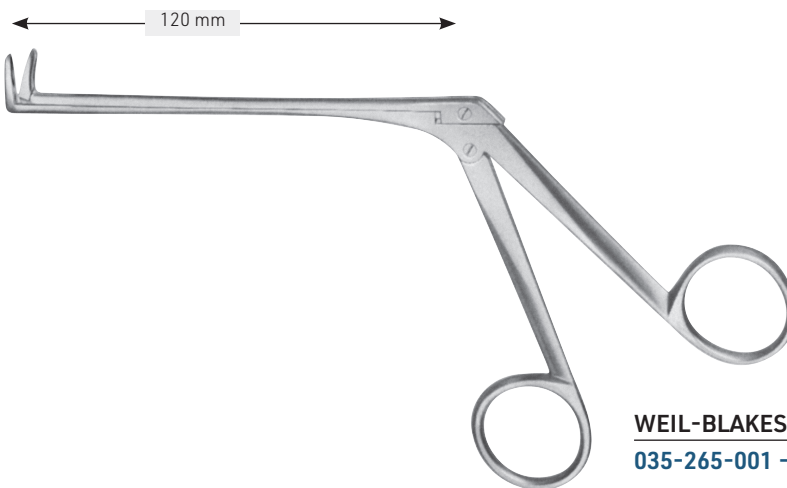

**WEIL-BLAKESLEY**

**035-265-001 - 035-265-004**

19,0 cm / 7 1/2"

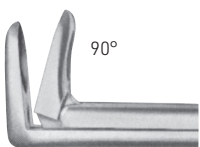

90°



FIG. 1

**035-265-001**

Maulbreite 3,0 mm  
 jaw width 3,0 mm  
 anchura de la boca 3,0 mm  
 larghezza della bocca 3,0 mm



FIG. 2

**035-265-002**

Maulbreite 3,5 mm  
 jaw width 3,5 mm  
 anchura de la boca 3,5 mm  
 larghezza della bocca 3,5 mm



FIG. 3

**035-265-003**

Maulbreite 4,5 mm  
 jaw width 4,5 mm  
 anchura de la boca 4,5 mm  
 larghezza della bocca 4,5 mm



FIG. 4

**035-265-004**

Maulbreite 5,0 mm  
 jaw width 5,0 mm  
 anchura de la boca 5,0 mm  
 larghezza della bocca 5,0 mm



035

Scharfe Nasenzangen  
Nasal Cutting Forceps  
Pinzas nasales cortantes  
Pinze taglienti per il naso

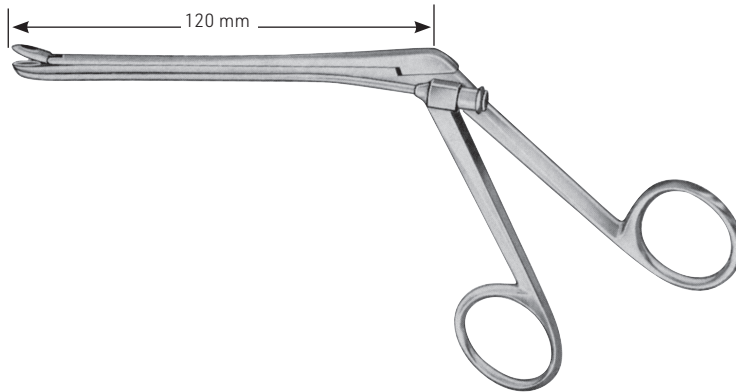

**WEIL-BLAKESLEY**

**035-271-001 - 035-279-003**

19,0 cm / 7 1/2"

gerade  
straight  
recta  
retta



**035-271-001** 2,5 mm



**035-271-002** 3,6 mm



**035-271-003** 4,8 mm

45° aufgebogen  
45° up curved  
45° curva arriba  
45° curva in alto



**035-273-001** 2,5 mm



**035-273-002** 3,6 mm



**035-273-003** 4,8 mm

90° aufgebogen  
90° up curved  
90° curva arriba  
90° curva in alto



**035-275-001** 2,5 mm



**035-275-002** 3,6 mm



**035-275-003** 4,8 mm

rechts gebogen  
right curved  
curva por derecha  
curva a destra



**035-277-001** 2,5 mm



**035-277-002** 3,6 mm



**035-277-003** 4,8 mm

links gebogen  
left curved  
curva por izquierda  
curva a sinistra



**035-279-001** 2,5 mm



**035-279-002** 3,6 mm



**035-279-003** 4,8 mm

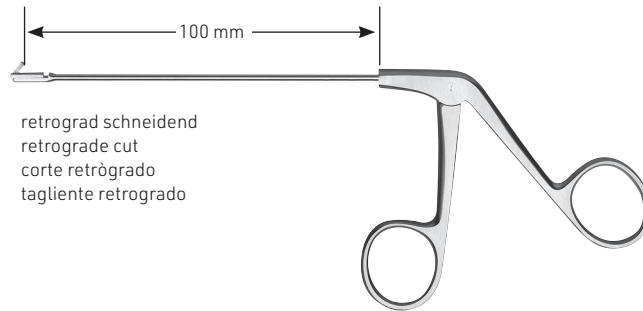

retrograd schneidend  
 retrograde cut  
 corte retrógrado  
 tagliente retrogrado

**STAMMBERGER**

**035-291-001 - 035-291-003**

Antrumstanze  
 Antrum Punch  
 Pinza saca-bocado para seno maxilar  
 Pinza tagliante per seno mascellare

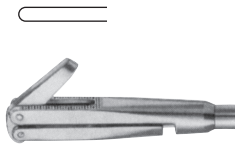

**035-291-001** 2 mm  
 oben schneidend  
 up cutting  
 cortante por arriba  
 tagliente in alto



**035-291-002** 2 mm  
 rechts schneidend  
 righth cutting  
 cortante a la derecha  
 tagliente a destra

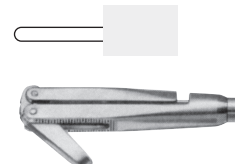

**035-291-003** 2 mm  
 links schneidend  
 left cutting  
 cortante a la izquierda  
 tagliente a sinistra

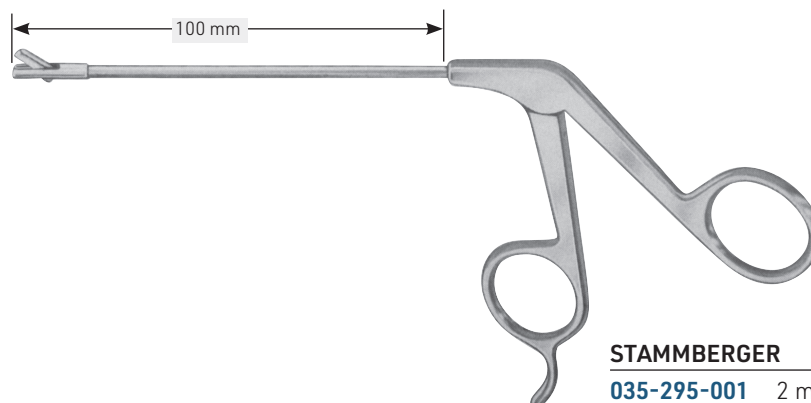

**STAMMBERGER**

**035-295-001** 2 mm



035

Nasenscheren  
Nasal scissors  
Tijeras nasales  
Forbici nasale

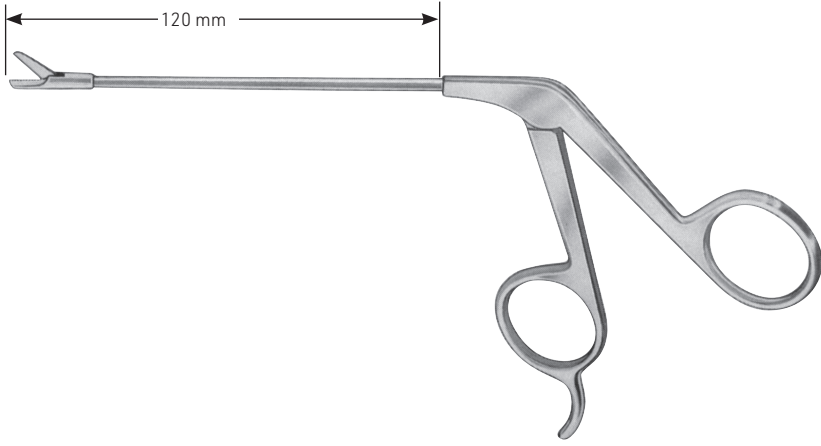

035-301-001 - 035-301-003



035-301-001 Ø 5 mm

gerade schneidend  
straight cutting  
cortante recto  
tagliente retto



035-301-002 Ø 5 mm

rechts gebogen schneidend  
right curved cutting  
cortante curva derecha  
tagliente curva destra



035-301-003 Ø 5 mm

links gebogen schneidend  
left curved cutting  
cortante curva izquierda  
tagliente curva sinistra

## MICRO

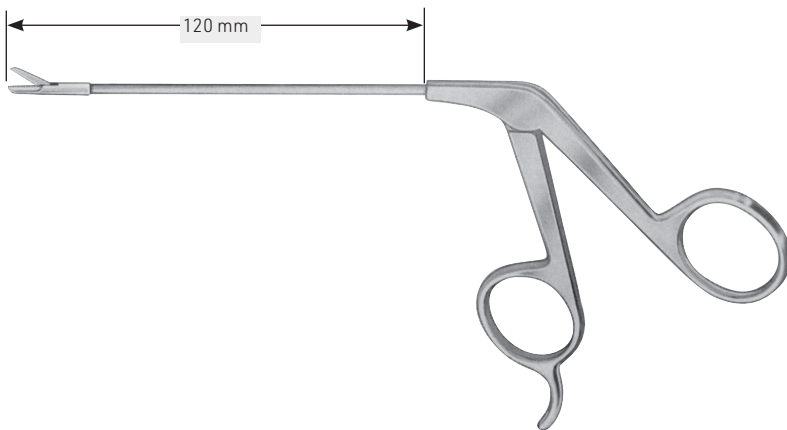

035-305-001 - 035-305-003



035-305-001 Ø 3,5 mm

gerade schneidend  
straight cutting  
cortante recto  
tagliente retto



035-305-002 Ø 3,5 mm

rechts gebogen schneidend  
right curved cutting  
cortante curva derecha  
tagliente curva destra



035-305-003 Ø 3,5 mm

links gebogen schneidend  
left curved cutting  
cortante curva izquierda  
tagliente curva sinistra

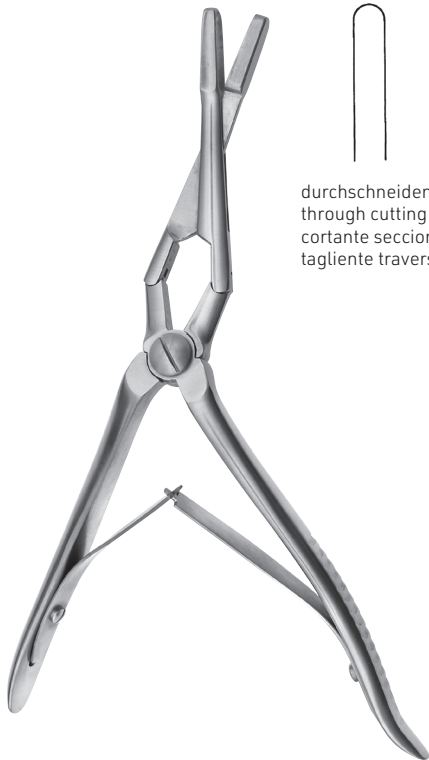

durchschneidend  
 through cutting  
 cortante seccional  
 tagliente trasverso

**MIDDLETON-JANSEN**

**035-321-190** 19,0 cm / 7 1/2"



**MIDDLETON-JANSEN**

**035-323-190** 19,0 cm / 7 1/2"

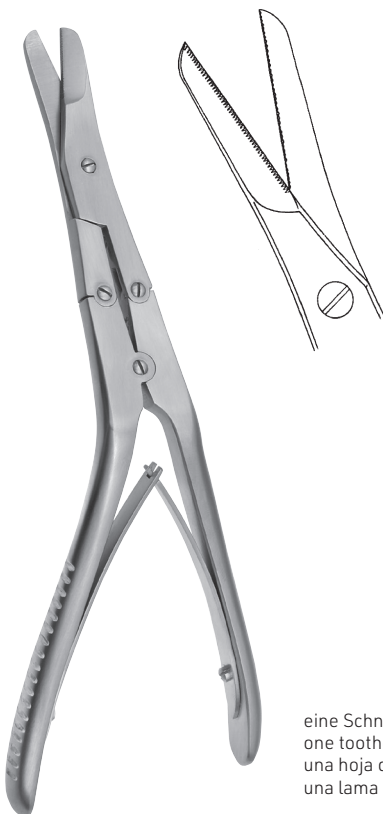

eine Schneide gezahnt  
 one toothed cutting edge  
 una hoja dentada  
 una lama dentata

**CAPLAN**

**035-325-200** 20,0 cm / 8"



**RUBIN**

**035-327-210** 21,0 cm / 8 1/4"



**035-328-001**

Schutzkappe  
 Protection Cap  
 Caperuza protectora  
 Calotta protettiva



035

Keilbeinstanzen  
Sphenoid Bone Punches  
Pinzas sacabocadas para esfenoides  
Pinze taglianti per seno sfenoidale

140 mm



4x4 mm



**035-340-040**

oben schneidend  
up cutting  
cortante por arriba  
tagliante in alto

4x4 mm



**035-342-040**

unten schneidend  
down cutting  
cortante por abajo  
tagliante in basso

**HAJEK**

**035-340-040 - 035-342-040**

14,0 cm / 5 1/2"

140 mm



3,5x3,5 mm



**035-344-035**

oben schneidend  
up cutting  
cortante por arriba  
tagliante in alto

3,5x3,5 mm



**035-346-035**

unten schneidend  
down cutting  
cortante por abajo  
tagliante in basso

**HAJEK-KOFLER**

**035-344-035 - 035-346-035**

14,0 cm / 5 1/2"





3x3 mm



**035-350-033**

oben schneidend  
 up cutting  
 cortante por arriba  
 tagliente in alto

4x4 mm



**035-350-044**

oben schneidend  
 up cutting  
 cortante por arriba  
 tagliente in alto

5x5 mm



**035-350-055**

oben schneidend  
 up cutting  
 cortante por arriba  
 tagliente in alto

6x6 mm



**035-350-066**

oben schneidend  
 up cutting  
 cortante por arriba  
 tagliente in alto

**KERRISON**

**035-350-033 - 035-350-066**

17,0 cm / 6<sup>3</sup>/<sub>4</sub>"



**034-450-015** 1,5 mm



**034-450-020** 2,0 mm



**034-450-030** 3,0 mm

**CITELLI**

**034-450-015 - 034-450-030**

17,0 cm / 6<sup>3</sup>/<sub>4</sub>"



035

Rhinoplastik-Messer  
Rhinoplastic Knives  
Cuchillos para rinoplástica  
Bisturi per plastica nasale

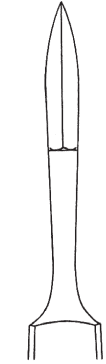

FIG. 1  
035-400-160

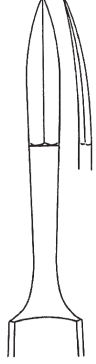

FIG. 2  
035-401-160

**JOSEPH**

035-400-160 - 035-401-160 16,0 cm / 6 1/4"



**FOMON**

035-405-160 16,0 cm / 6 1/4"

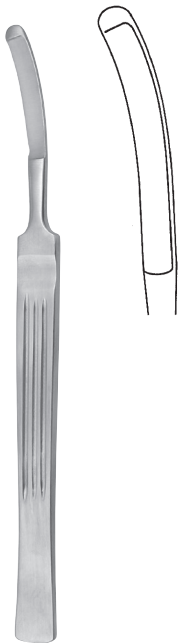

**CONVERSE**

035-407-160 16,0 cm / 6 1/4"

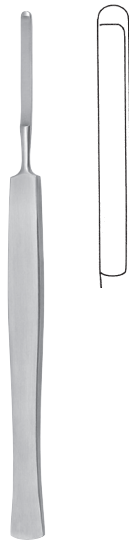

**JOSEPH**

035-408-150 15,0 cm / 6"



**COTTLE**

035-410-150 15,0 cm / 6"



Mukosamesser  
Mucosa Knife  
cuchillo para mucosa  
Bisturi per mucosa

**FREER**

**035-420-165** 16,5 cm / 6 1/2"

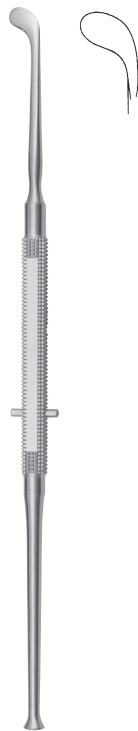

**FREER**

**035-423-190** 19,0 cm / 7 1/2"

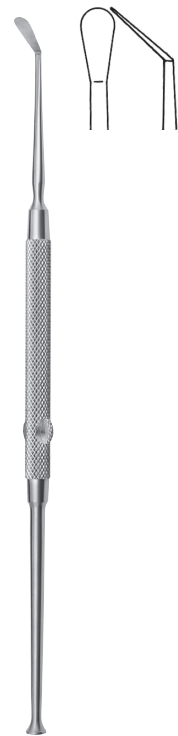

**FREER**

**035-425-190** 19,0 cm / 7 1/2"



035

Septummesser, Schwingmesser  
Septum Knives, Swivel Knives  
Cuchillos para tabique nasal  
Bisturi per il setto nasale

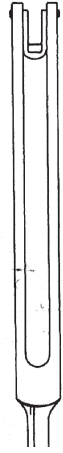

035-430-003 3,0 mm

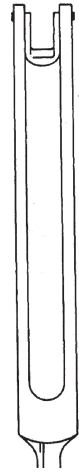

035-430-004 4,0 mm

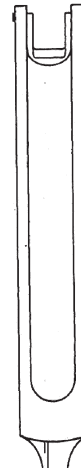

035-430-005 5,0 mm

**BALLENGER**

035-430-003 - 035-430-005 21,0 cm / 8<sup>1</sup>/<sub>4</sub>"

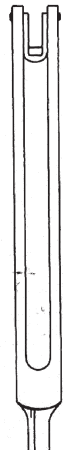

035-431-003 3,0 mm

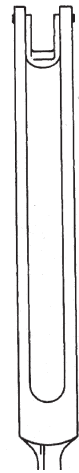

035-431-004 4,0 mm



035-431-005 5,0 mm

**BALLENGER**

035-431-003 - 035-431-005 21,0 cm / 8<sup>1</sup>/<sub>4</sub>"



Septummesser  
 Septum Knife  
 Cuchillo para tabique nasal  
 Bisturi per il setto nasale

**BRUENINGS**

**035-435-165** 16,5 cm / 6 1/2"



4 mm

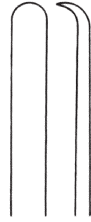

**035-441-004**

5 mm

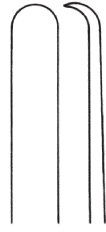

**035-441-005**



3,5 mm



**HALLE**

**035-443-160** 16,0 cm / 6 1/4"



4 mm



**JOSEPH**

**035-445-160** 16,0 cm / 6 1/4"

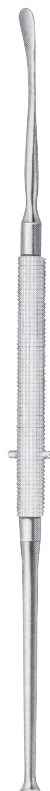

5 mm



**035-449-190**

scharf  
 sharp  
 agudo  
 acuto

6 mm



**035-451-190**

stumpf  
 blunt  
 romo  
 smusso

**FREER**

**035-449-190 - 035-451-190** 19,0 cm / 7 1/2"



5 mm

scharf / stumpf  
 sharp / blunt  
 agudo / romo  
 acuto / smusso

5 mm



**FREER**

**035-455-180** 18,0 cm / 7"



035

Septumelevatorien  
Septum Elevators  
Elevadores para tabique nasal  
Elevatori per il setto nasale

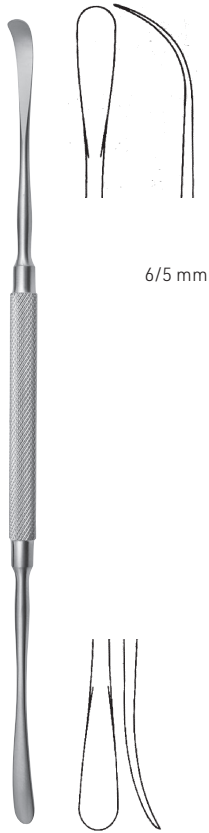

6/5 mm

**FREER**

**035-457-205** 20,5 cm / 8"



4 / 4 mm

**MC KENTY**

**035-459-220** 22,0 cm / 8<sup>3</sup>/<sub>4</sub>"

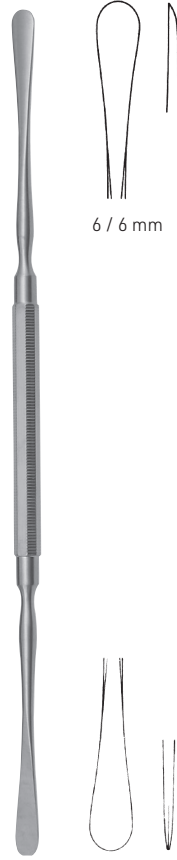

6 / 6 mm

**BALLENGER-HAJEK**

**035-460-220** 22,0 cm / 8<sup>3</sup>/<sub>4</sub>"



5 / 5 mm

**COTTLE**

**035-463-235** 23,5 cm / 9<sup>1</sup>/<sub>4</sub>"

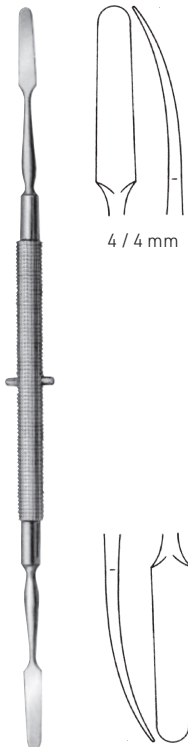

4 / 4 mm

**KILIAN**

**035-465-180** 18,0 cm / 7"

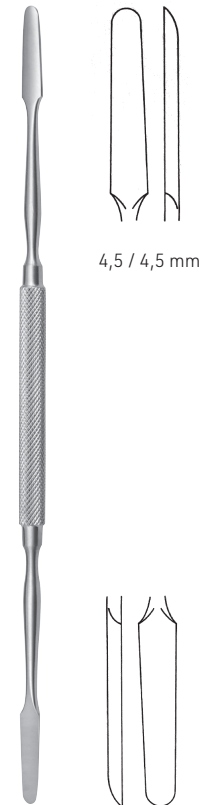

4,5 / 4,5 mm

**KILIAN**

**035-468-220** 22,0 cm / 8<sup>3</sup>/<sub>4</sub>"

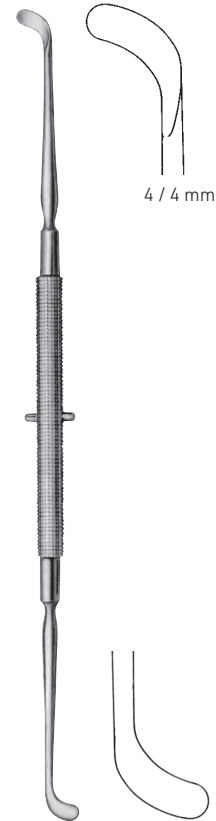

4 / 4 mm

**PENNINGTON**

**035-469-215** 21,5 cm / 7<sup>1</sup>/<sub>4</sub>"

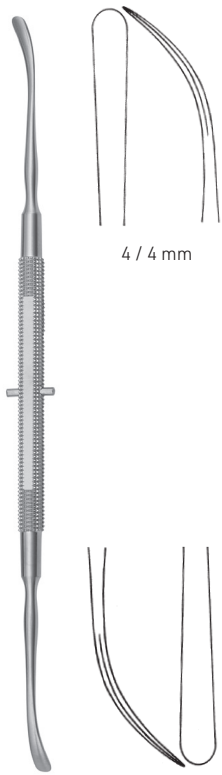

4 / 4 mm

**ROGER**

**035-481-195** 19,5 cm / 7<sup>3</sup>/<sub>4</sub>"



4 mm

**JOSEPH-MASING**

**035-483-215** 21,5 cm / 8<sup>1</sup>/<sub>2</sub>"



3,3 / 3,7 mm

**COTTLE**

**035-485-220** 22,0 cm / 8<sup>3</sup>/<sub>4</sub>"

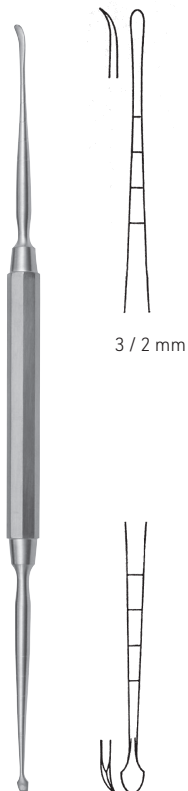

3 / 2 mm

**MASING**

**035-487-210** 21,0 cm / 8<sup>1</sup>/<sub>4</sub>"

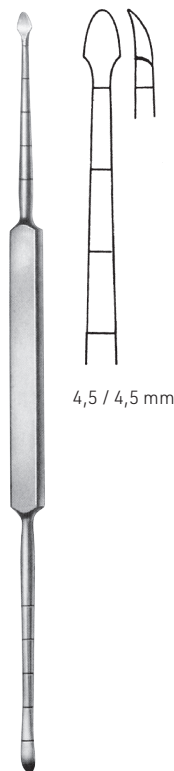

4,5 / 4,5 mm

**COTTLE**

**035-489-210** 21,0 cm / 8<sup>1</sup>/<sub>4</sub>"

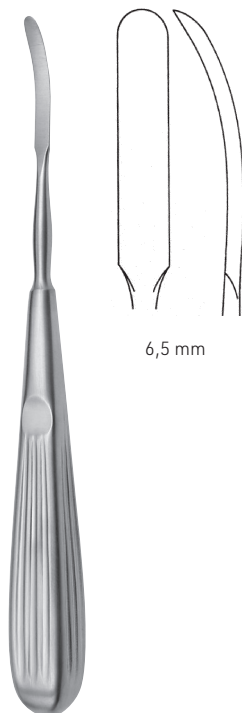

6,5 mm

**JOSEPH**

**035-493-160** 16,0 cm / 8<sup>1</sup>/<sub>4</sub>"



035

Septummeißel  
Septum Chisels  
Cinceles para tabique nasal  
Scalpello per il setto nasale



**FREER**

**035-500-160** 16,0 cm / 6<sup>1</sup>/<sub>4</sub>"



**FREER**

**035-501-160** 16,0 cm / 6<sup>1</sup>/<sub>4</sub>"

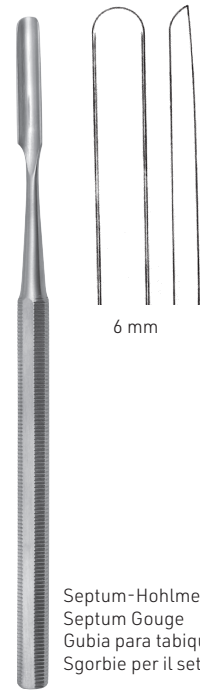

Septum-Hohlmeißel  
Septum Gouge  
Gubia para tabique nasal  
Sgorbie per il setto nasale

**FREER**

**035-510-150** 15,0 cm / 6"





**035-520-002** 2 mm



**035-520-004** 4 mm



**035-520-006** 6 mm

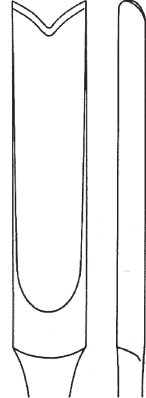

**035-520-008** 8 mm

**BALLENGER**

**035-520-002 - 035-520-008** 15,0 cm / 6"

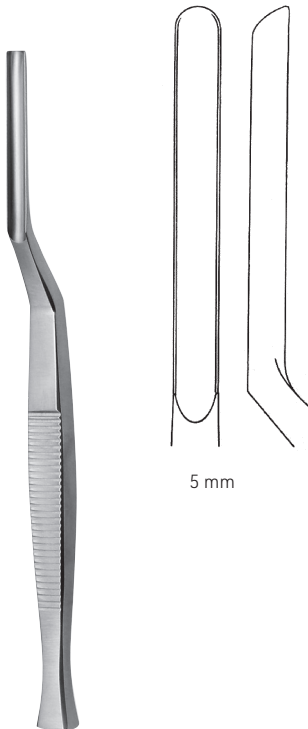

5 mm

**KILLIAN**

**035-525-160** 16,0 cm / 6 1/4"

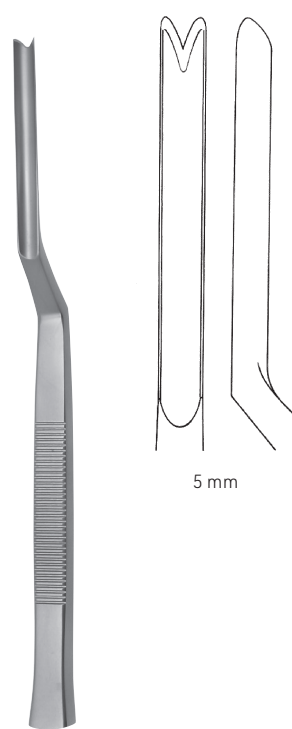

5 mm

**KILLIAN**

**035-529-160** 16,0 cm / 6 1/4"



035

Osteotome  
Osteotomes  
Osteótomos  
Osteotomi



**035-530-004** 4 mm



**035-530-007** 7 mm



**035-530-009** 9 mm

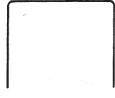

**035-530-012** 12 mm

**COTTLE**

**035-530-004 - 035-530-012** 18,0 cm / 7"



6 mm

**COTTLE**

**035-535-006** 18,0 cm / 7"



**035-540-004** 4 mm



**035-540-007** 7 mm



**035-540-009** 9 mm

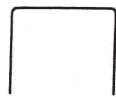

**035-540-012** 12 mm

**COTTLE**

**035-540-004 - 035-540-012** 18,0 cm / 7"

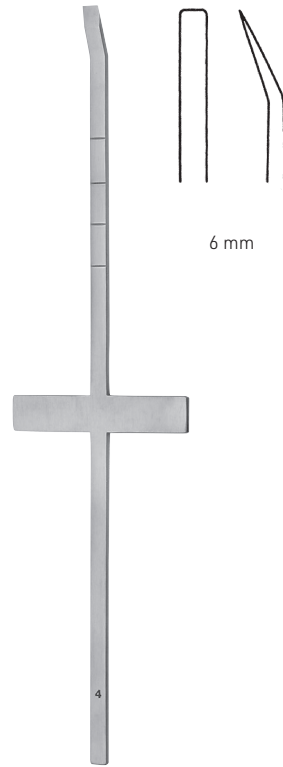

6 mm

**COTTLE**

**035-543-006** 18,0 cm / 7"

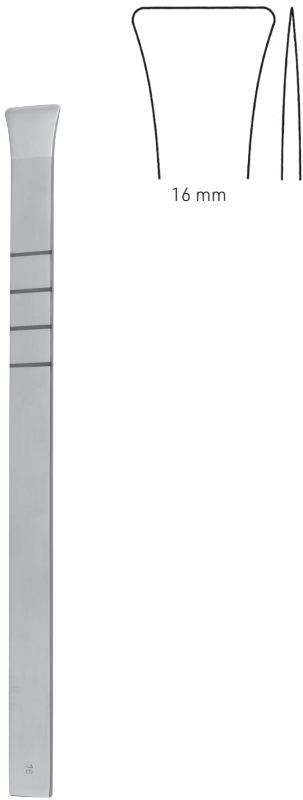

16 mm

**COTTLE**  
**035-546-016** 18,0 cm / 7"

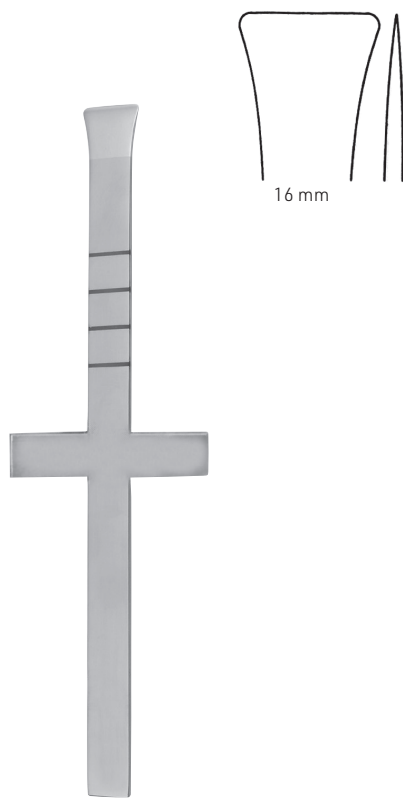

16 mm

**COTTLE**  
**035-548-016** 18,0 cm / 7"

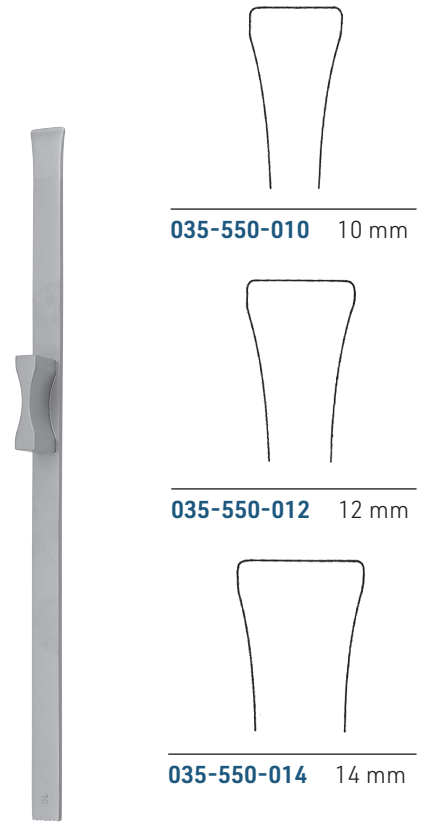

**035-550-010** 10 mm



**035-550-012** 12 mm

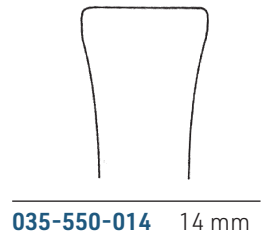

**035-550-014** 14 mm

**RUBIN**  
**035-550-010 - 035-550-014** 18,0 cm / 7"

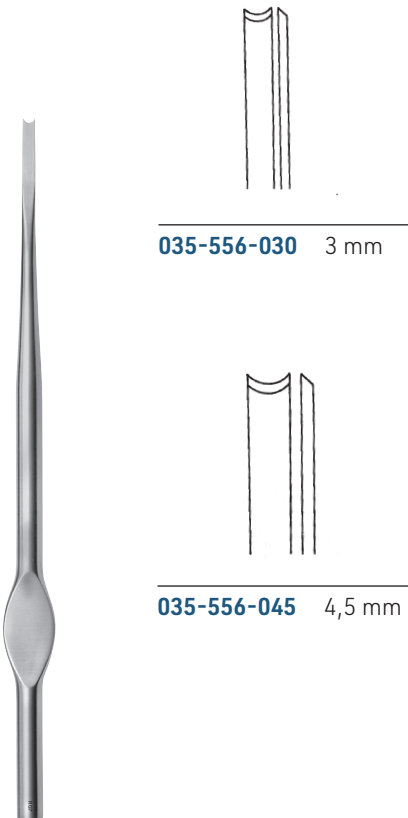

**035-556-030** 3 mm

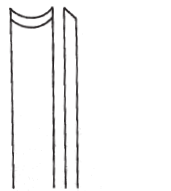

**035-556-045** 4,5 mm

**WALTER**  
**035-556-030 - 035-556-045** 19,0 cm / 7½"

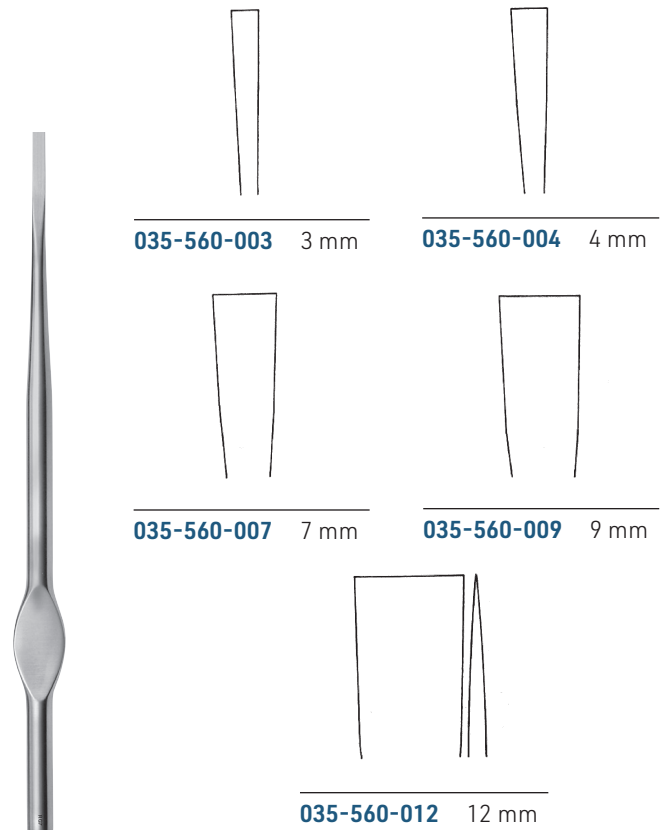

**035-560-003** 3 mm

**035-560-004** 4 mm

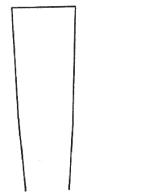

**035-560-007** 7 mm

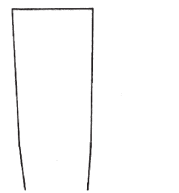

**035-560-009** 9 mm

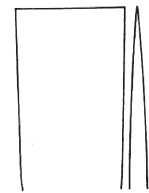

**035-560-012** 12 mm

**WALTER**  
**035-560-003 - 035-560-012** 19,0 cm / 7½"



035

Osteotome  
Osteotomes  
Osteótomos  
Osteotomi

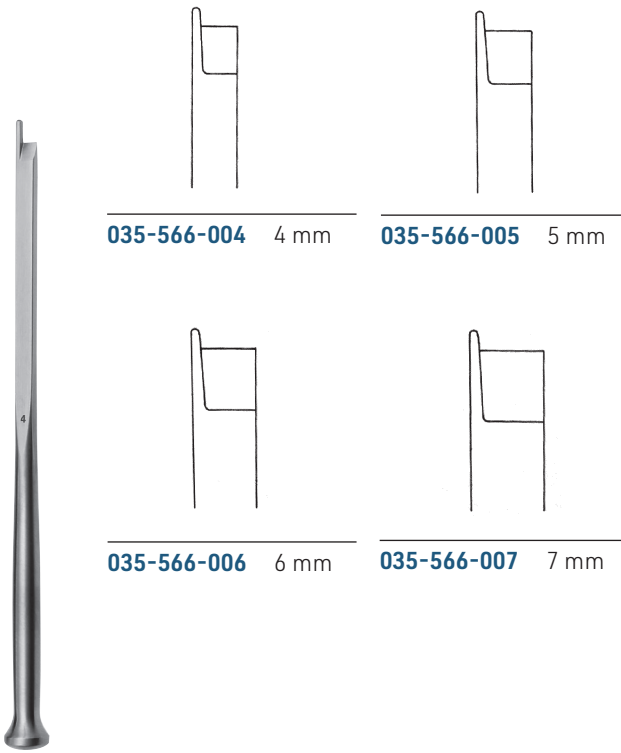

035-566-004 4 mm

035-566-005 5 mm

035-566-006 6 mm

035-566-007 7 mm

**FOMON**

035-566-004 - 035-566-007 16,0 cm / 6 1/4"

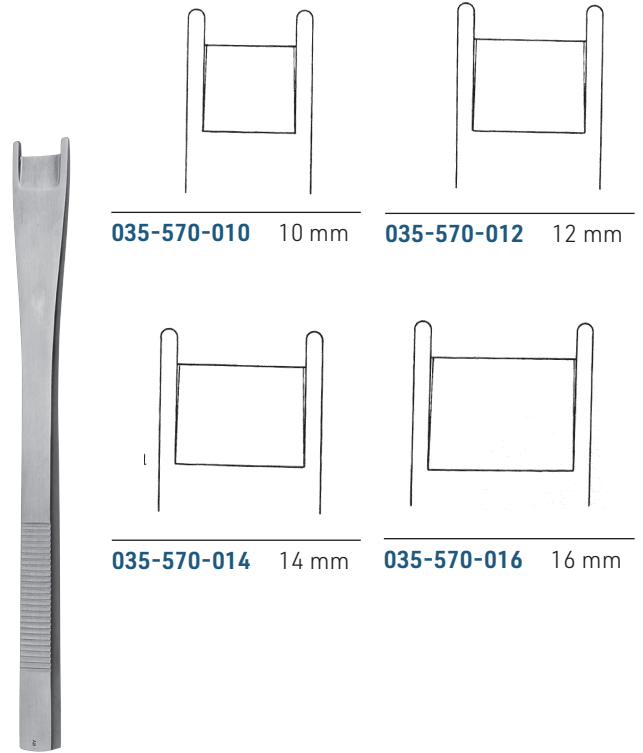

035-570-010 10 mm

035-570-012 12 mm

035-570-014 14 mm

035-570-016 16 mm

**CINELLI**

035-570-010 - 035-570-016 16,0 cm / 6 1/4"

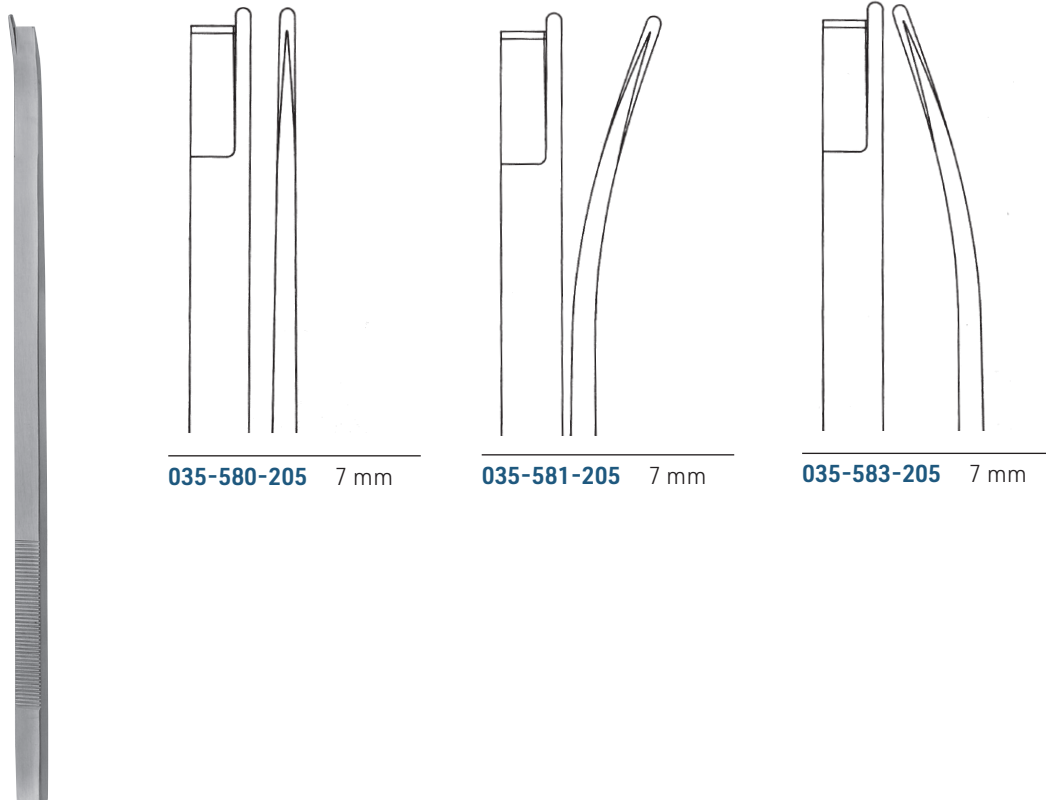

035-580-205 7 mm

035-581-205 7 mm

035-583-205 7 mm

**NEIVERT-ANDERSON**

035-580-205 - 035-583-205 20,5 cm / 8"



**035-590-002** 2 mm



**035-590-003** 3 mm



**035-50-004** 4 mm

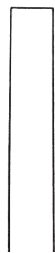

**035-590-005** 5 mm



**035-590-006** 6 mm



**035-590-007** 7 mm



**035-590-008** 8 mm



**035-590-010** 10 mm



**035-590-012** 12 mm

**SHEEHAN**

**035-590-002 - 035-590-012** 15,0 cm / 6"



035

Osteotome  
Osteotomes  
Osteótomos  
Osteotomi



5 mm

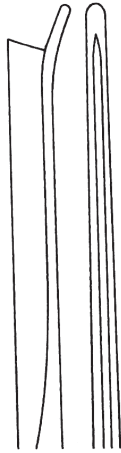

**035-594-001**

gerade  
straight  
recto  
retto

5 mm

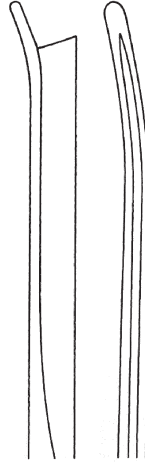

**035-594-002**

rechts  
right  
derecho  
destra

5 mm

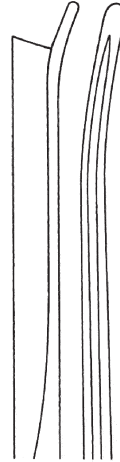

**035-594-003**

links  
left  
izquierdo  
sinistra

**SILVER**

**035-594-001 - 035-594-003**

18,0 cm / 7"

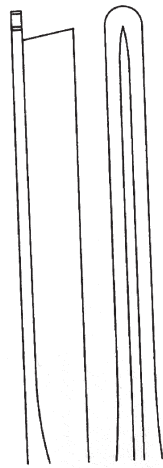
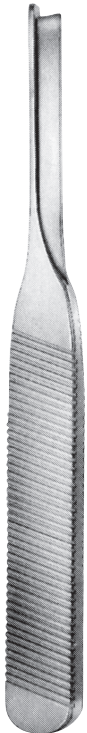

**PARKES**

**035-596-160** 16,0 cm / 6<sup>1</sup>/<sub>4</sub>"



links abgewinkelt  
 angeled to left  
 angulado por izquierdo  
 anguato a sinistra

**JOSEPH**

**035-611-001** 17,0 cm / 6<sup>3</sup>/<sub>4</sub>"



rechts abgewinkelt  
 angeled to right  
 angulado por derecho  
 anguato a destra

**JOSEPH**

**035-611-002** 17,0 cm / 6<sup>3</sup>/<sub>4</sub>"

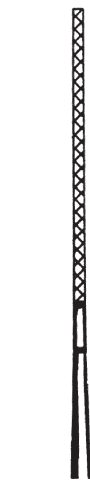

**035-620-190**

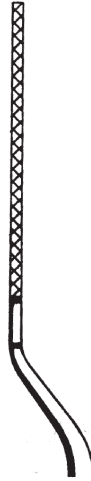

**035-621-190**



**035-623-190**

Arbeitslänge 40 mm  
 working length 40 mm  
 longitud de la punta 40 mm  
 lunghezza utile 40 mm

**JOSEPH**

**035-620-190 - 035-623-190** 19,0 cm / 7<sup>1</sup>/<sub>2</sub>"

Knorpelquetsche  
 Cartilage Crusher  
 Machacadora  
 Torchio per cartilagine

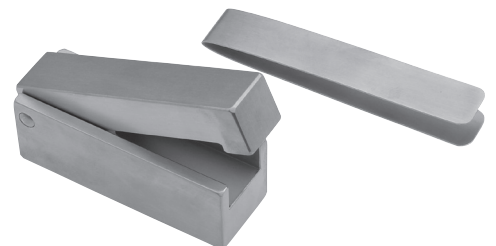

**COTTLE**

**035-630-000**



035

Nasenraspeln, Knochenfeilen, Antrumraspeln  
 Nasal Rasps, Bone Files, Antrum Rasps  
 Escofinas nasales, Limas para huesos, Escofinas para el antro  
 Raspe nasali, Lime per ossa, Raspe per seno mascellare

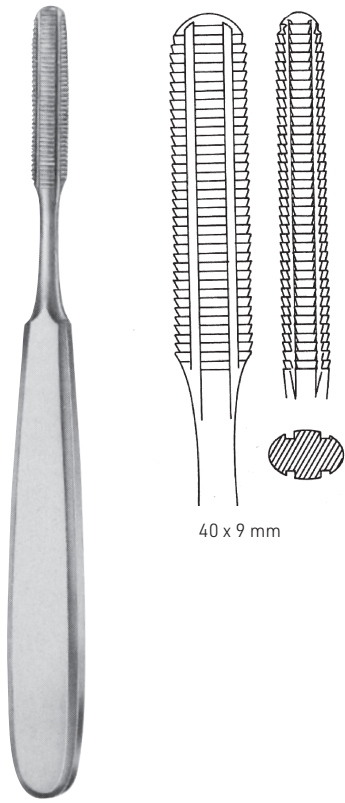

40 x 9 mm

**MALTZ**

**035-650-175** 17,5 cm / 7"

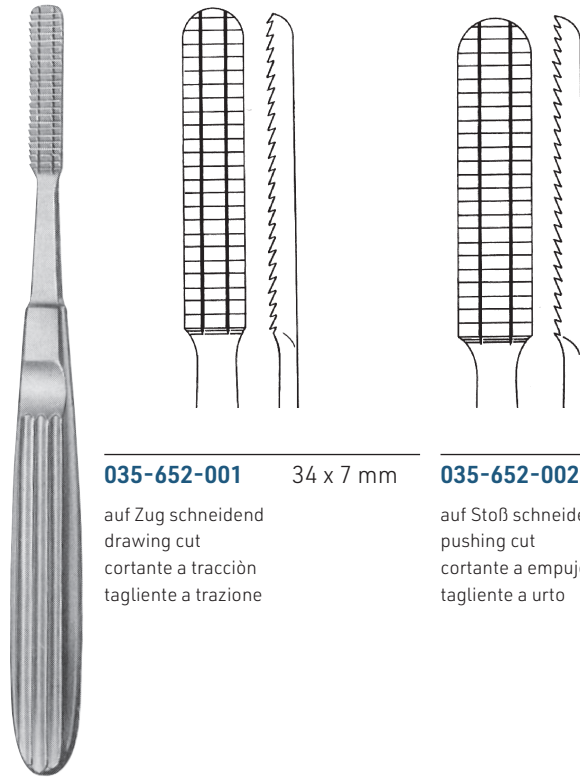

**035-652-001** 34 x 7 mm

auf Zug schneidend  
drawing cut  
cortante a tracciòn  
tagliante a trazione

**035-652-002** 34 x 7 mm

auf Stoß schneidend  
pushing cut  
cortante a empuje  
tagliante a urto

**MALTZ**

**035-652-001 - 035-652-002** 17,0 cm / 6<sup>3</sup>/<sub>4</sub>"

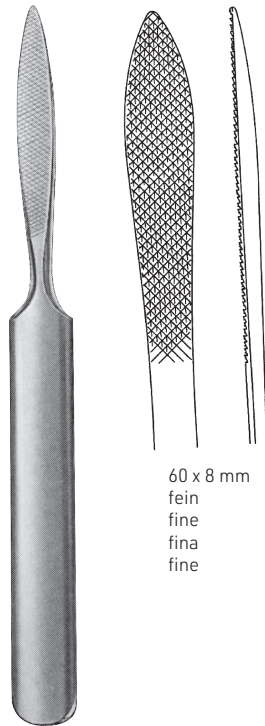

60 x 8 mm  
fein  
fine  
fina  
fine

**JOSEPH**

**035-654-160** 16,0 cm / 6<sup>1</sup>/<sub>4</sub>"

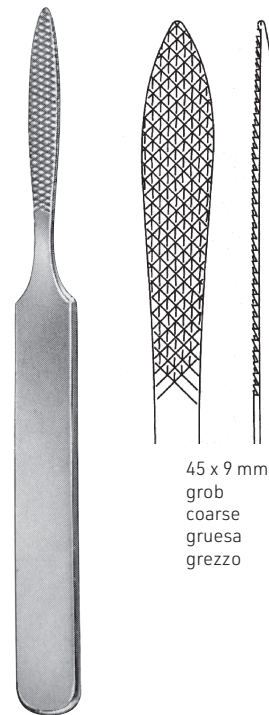

45 x 9 mm  
grob  
coarse  
gruesa  
grezzo

**JOSEPH**

**035-655-160** 16,0 cm / 6<sup>1</sup>/<sub>4</sub>"



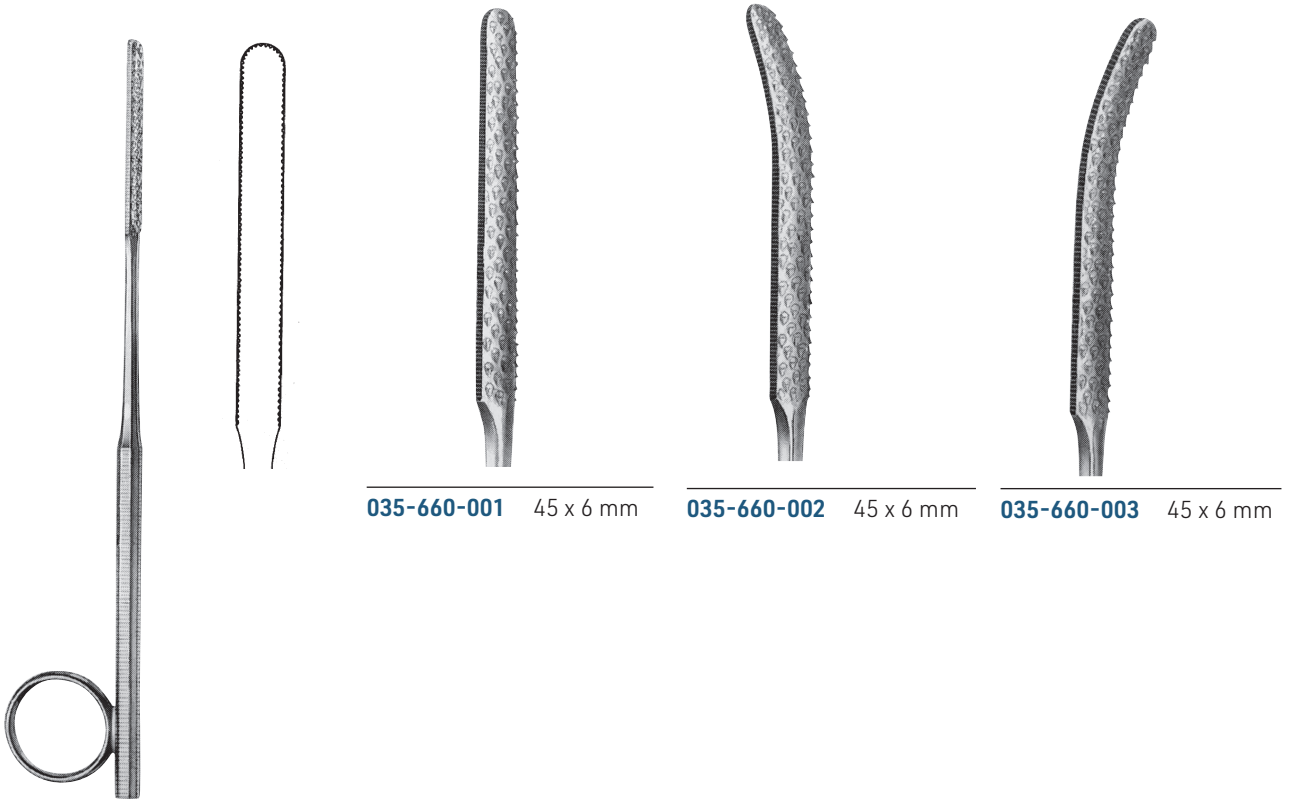

**035-660-001** 45 x 6 mm

**035-660-002** 45 x 6 mm

**035-660-003** 45 x 6 mm

**GALLAHER**

**035-660-001 - 035-660-003** 17,0 cm / 6<sup>3</sup>/<sub>4</sub>"

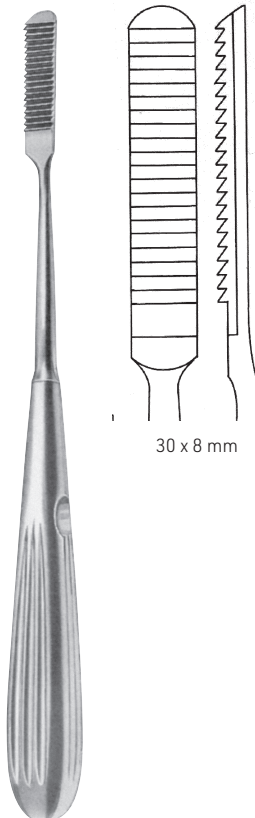

30 x 8 mm

**COTTLE**

**035-664-210** 21,0 cm / 8<sup>1</sup>/<sub>4</sub>"

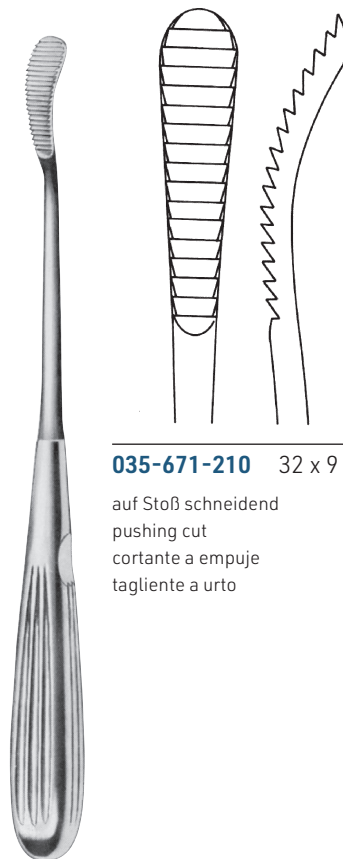

**035-671-210** 32 x 9 mm

auf Stoß schneidend  
 pushing cut  
 cortante a empuje  
 tagliente a urto

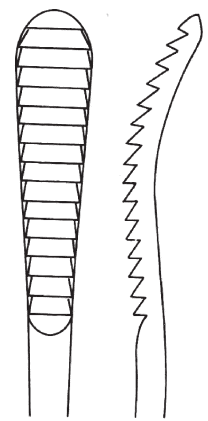

**035-673-210** 32 x 9 mm

auf Zug schneidend  
 drawing cut  
 cortante a tracciòn  
 tagliente a trazione

**AUFRICHT**

**035-671-210 - 035-673-210** 21,0 cm / 8<sup>1</sup>/<sub>4</sub>"



035

Nasenraspeln  
Nasal Rasps  
Escofinas nasales  
Raspe nasali

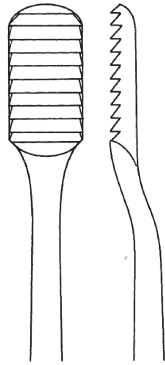

**035-674-190**

auf Zug schneidend  
drawing cut  
cortante a traccion  
tagliente a trazione

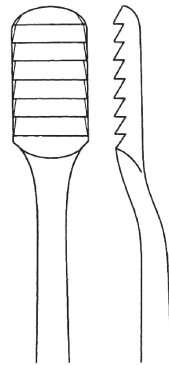

**035-676-190**

auf Zug schneidend  
drawing cut  
cortante a traccion  
tagliente a trazione

**LEWIS**

**035-674-190 - 035-676-190** 19,0 cm / 7 1/2"



fein / grob  
fine / coarse  
fina / gruesa  
fino / grezzo

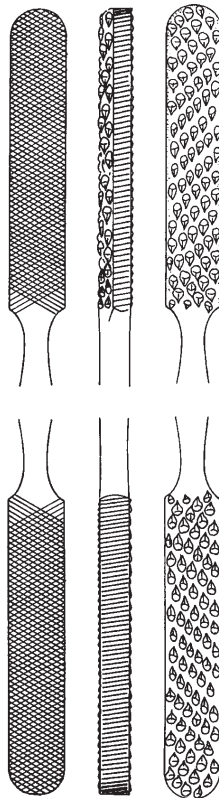

30 x 8 mm

**FOMON**

**035-680-210** 21,0 cm / 8 1/4"

TC

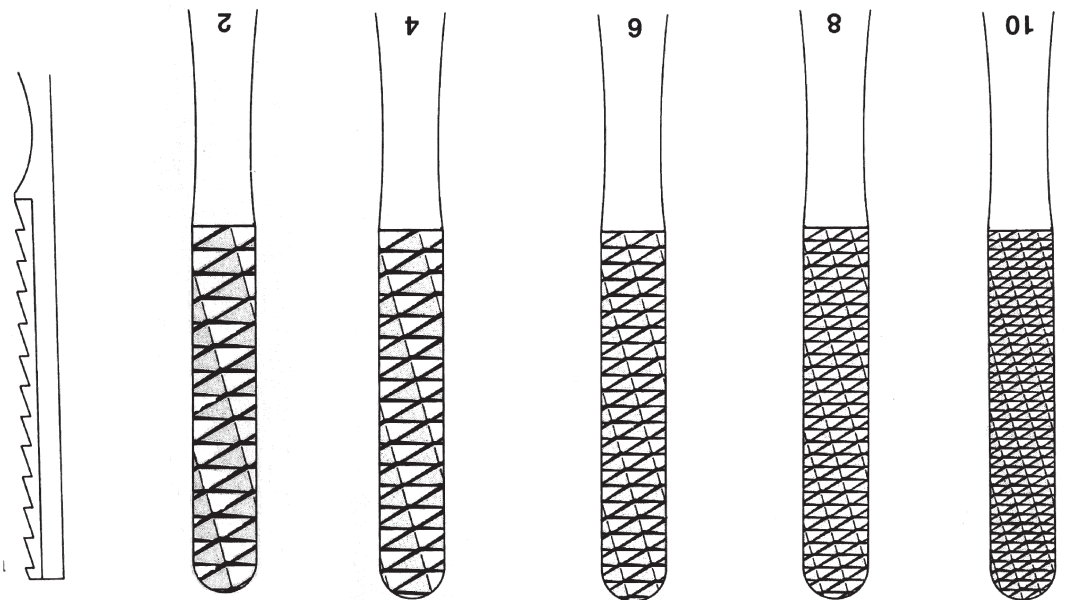
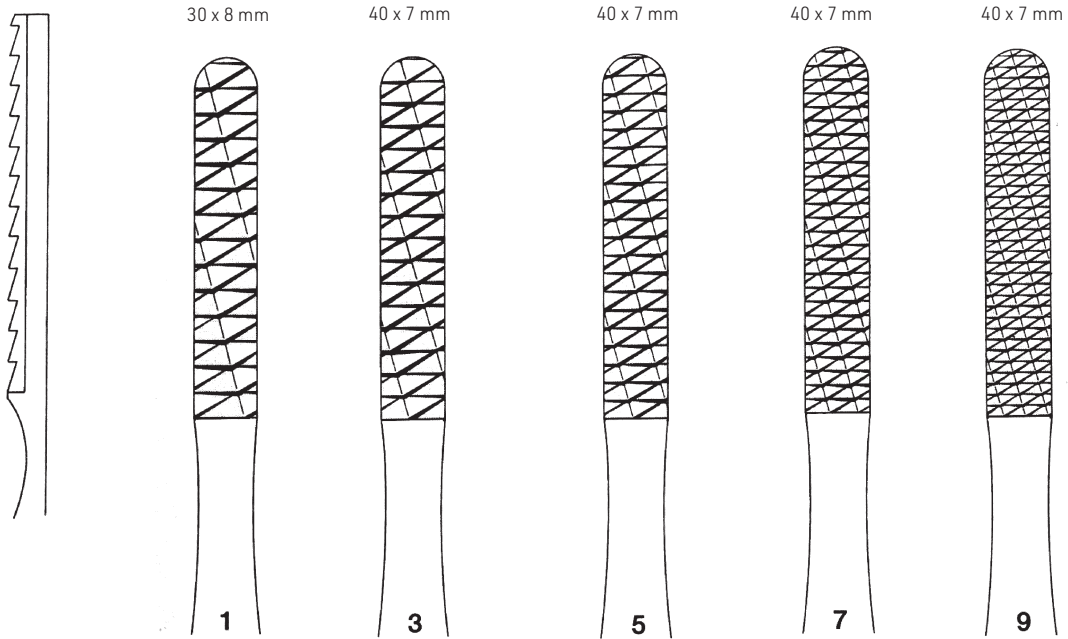

Fig. 1/2  
 035-690-012

Fig. 3/4  
 035-690-034

Fig. 5/6  
 035-690-056

Fig. 7/8  
 035-690-078

Fig. 9/10  
 035-690-090



FOMON

035-690-012 - 035-690-090

20,5 cm / 8"



035

Nasenhäkchen, Nasenhaken  
Nasal Hooks, Nasal Retractors  
Ganchitos nasales, Separadores nasales  
Uncini nasali, Divaricatori nasali



scharf  
sharp  
agudo  
acuto

**COTTLE**

**035-701-170** 17,0 cm / 6<sup>3</sup>/<sub>4</sub>"



**035-703-001**

scharf  
sharp  
agudo  
acuto



**035-703-002**

scharf  
sharp  
agudo  
acuto



**035-703-003**

scharf  
sharp  
agudo  
acuto



Knopfende  
button end  
punta abotonada  
fine abbottonato

**LANGE**

**035-705-220** 22,0 cm / 8<sup>3</sup>/<sub>4</sub>"

Nasenflügelhäkchen  
Alar Hooklet  
Ganchito para alas de nariz  
Uncino per le inne  
nasali

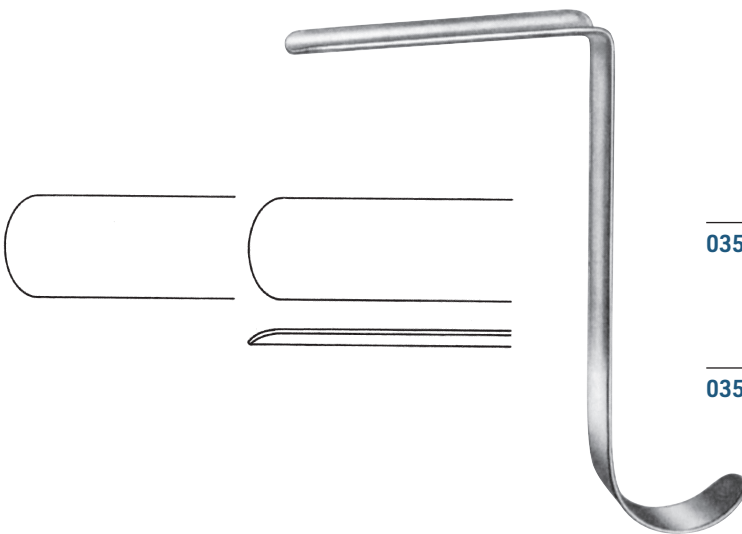

**035-709-001** 20 x 9 mm

**035-709-002** 28 x 13 mm

**035-709-003** 41 x 13 mm

**035-709-004** 60 x 14 mm

**CONVERSE**

**035-709-001 - 035-709-004** 9,0 cm / 3<sup>1</sup>/<sub>2</sub>"



Knopfende  
button end  
punta abotonada  
fine abbottonato

**FOMON**

**035-711-170** 17,0 cm / 7 1/2"

Nasenflügelhäkchen  
Alar Hooklet  
Ganchito para alas de nariz  
Uncino per le inne  
nasali

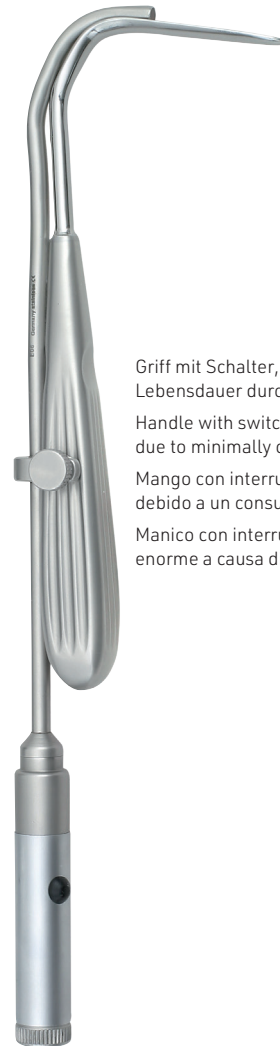

Griff mit Schalter, integrierter Batterie. Extrem lange Lebensdauer durch minimale Stromaufnahme.

Handle with switch, included battery. Substandard lifetime due to minimally current consumption.

Mango con interruptor, bateria incluida. Enorme vida útil debido a un consumo mínimo de corriente.

Manico con interruttore, batteria inclusa. La vita utile ed enorme a causa di un minimo consumo di corrente.

**035-716-215** 21,5 cm / 8 1/2"

Nasenrückenhaken mit Fiberglas-Lichtträger  
Nasal retractor with fiber optic light carrier  
Separador nasal con portador de luz fibra óptica  
Divaricatore nasale con supporto per illuminazione fibra ottica



035

Nasenhäkchen  
Nasal Hooks  
Ganchitos nasales  
Uncini nasali

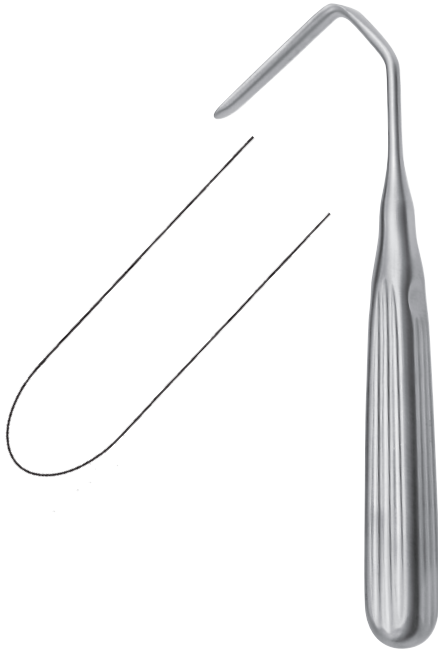

**AUFRIECHT**

**035-715-160** 16,0 cm / 6<sup>1</sup>/<sub>4</sub>"



**KILNER**

**035-717-080** 8,0 cm / 3<sup>1</sup>/<sub>2</sub>"

Nasenflügelhäkchen  
Alar Hooklet  
Ganchito para alas de nariz  
Uncino per le inne  
nasali

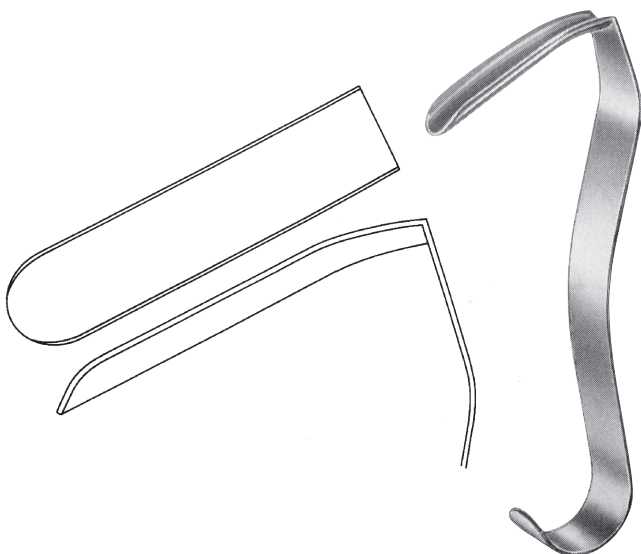

Blatt 45 x 10 mm  
blade 45 x 10 mm  
hoja 45 x 10 mm  
lama 45 x 10 mm

**CONVERSE**

**035-719-105** 10,5 cm / 4"

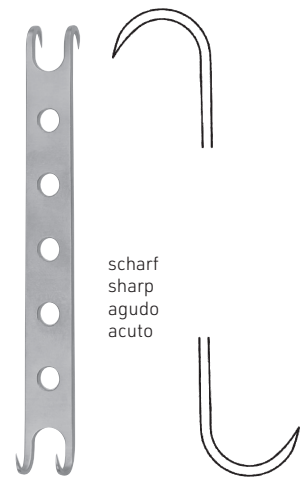

scharf  
sharp  
agudo  
acuto

**CONVERSE**

**035-721-115** 12 cm / 4<sup>3</sup>/<sub>4</sub>"

Nasenflügelhäkchen  
Alar Hooklet  
Ganchito para alas de nariz  
Uncino per le inne  
nasali



scharf  
 sharp  
 agudo  
 acuto

**FREER**

**035-723-150** 15,0 cm / 6"



**JOSEPH**

**035-725-001** 15,0 cm / 6"

Schleimhauthäkchen  
 Mucosa Hooklet  
 Ganchito para mucosa  
 Uncino per mucosa



**JOSEPH**

**035-725-002 - 035-725-010** 16,0 cm / 6 1/4"



**035-725-002**



**035-725-005**



**035-725-007**



**035-725-010**

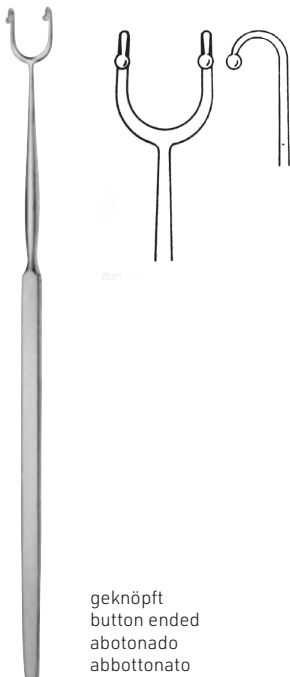

geknöpft  
 button ended  
 abotonado  
 abbottonato

**FOMON**

**035-729-160** 16,0 cm / 6 1/4"



geknöpft  
 button ended  
 abotonada  
 abbottonato

**COTTLE-NEIVERT**

**035-731-200** 20,0 cm / 8"



**035-733-001**

scharf  
 sharp  
 agudo  
 acuto



**035-733-002**

geknöpft / scharf  
 button end / sharp  
 abotonado / agudo  
 abbotto nato / acuto



**035-733-003**

scharf / geknöpft  
 sharp / button end  
 agudo / abotonado  
 acuto / abbottonato

**COTTLE**

**035-733-001 - 035-733-003** 14,5 cm / 5 3/4"



035

Nasenflügelhäkchen  
Alar Hooklets  
Ganchitos para alas de nariz  
Uncini per le pinne nasali



**COTTLE**

**035-735-140** 14,0 cm / 5 1/2"

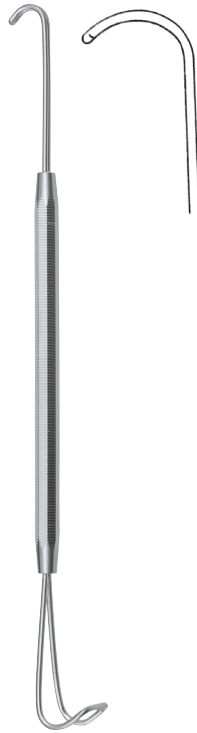

**NEIVERT**

**035-737-170** 17,0 cm / 6 3/4"



**COTTLE**

**035-741-140** 14,0 cm / 5 1/2"

Sattelhäkchen  
Saddle Hook  
Separador en forma de silla  
Elevatori in forma di sella



**COTTLE**

**035-743-160** 16,0 cm / 6 1/4"



Blatt  
blade  
hoja  
lama  
60 x 6,5 mm

stumpf  
blunt  
romo  
smusso

**AUFRICT**

**035-745-120** 12,0 cm / 4 3/4"



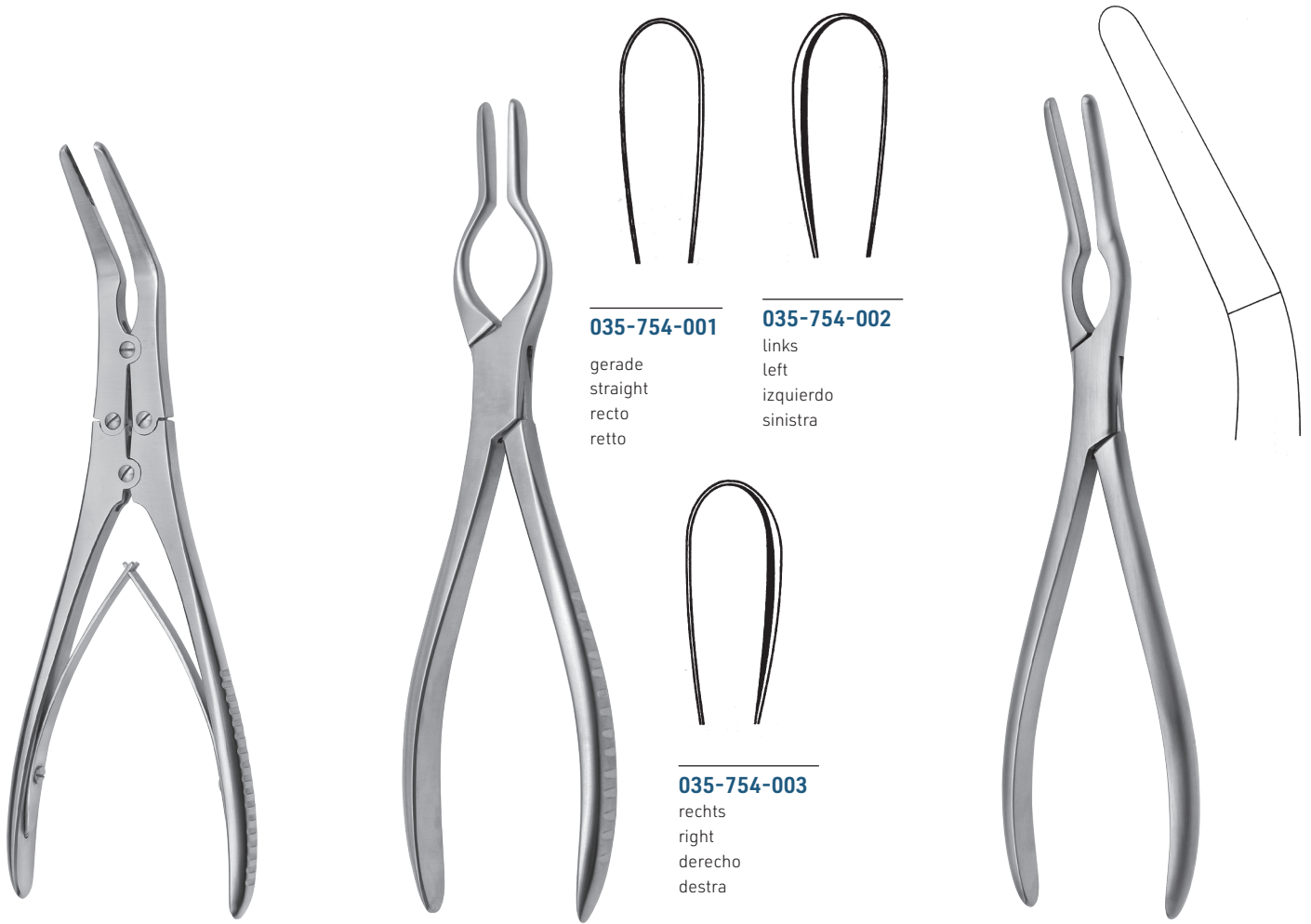

**035-754-001**

gerade  
 straight  
 recto  
 retto

**035-754-002**

links  
 left  
 izquierdo  
 sinistra

**035-754-003**

rechts  
 right  
 derecho  
 destra

**KRESSNER**

**035-751-210** 21,0 cm / 8<sup>1</sup>/<sub>4</sub>"

**COTTLE-WALSHAM**

**035-754-001 - 035-754-003** 23,0 cm / 9"

**ASCH**

**035-757-225** 22,5 cm / 8<sup>3</sup>/<sub>4</sub>"

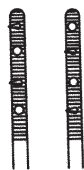

1,7 mm breit mit Zähnen  
 1,7 mm wide with teeth  
 1,7 mm de ancho con dientes  
 largo 1,7 mm con denti

**COTTLE**

**035-765-140** 14,0 cm / 5<sup>1</sup>/<sub>2</sub>"

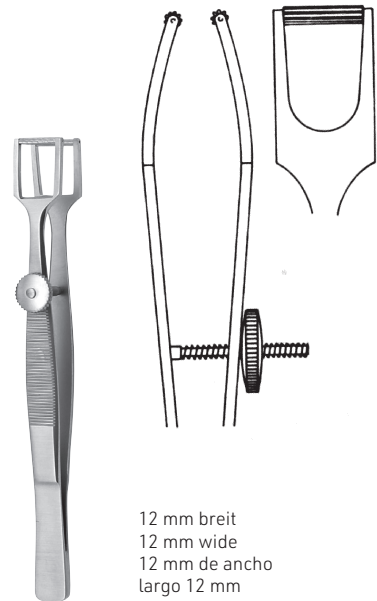

12 mm breit  
 12 mm wide  
 12 mm de ancho  
 largo 12 mm

**COTTLE**

**035-766-110** 11,0 cm / 4<sup>1</sup>/<sub>4</sub>"



035

Ringmesser  
Adenoid Currettes  
Cuchillos para adenoides  
Coltelli per vegetazioni adenoidee



**FAULKNER**

**035-781-210** 21,0 cm / 8<sup>1</sup>/<sub>4</sub>"



**COAKLEY**

**035-785-001 - 035-785-006** 17,0 cm / 6<sup>3</sup>/<sub>4</sub>"



**035-785-001**



**035-785-002**



**035-785-003**



**035-785-004**



**035-785-005**



**035-785-006**



**BECKMANN**

**035-800-001 - 035-800-006** 22,0 cm / 8<sup>3</sup>/<sub>4</sub>"

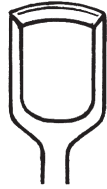

FIG. 1

**035-800-001** 10 mm



FIG. 2

**035-800-002** 12 mm

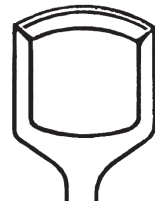

FIG. 3

**035-800-003** 14 mm

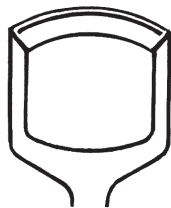

FIG. 4

**035-800-004** 16 mm

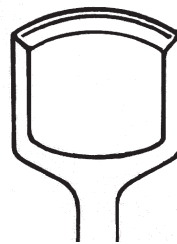

FIG. 5

**035-800-005** 20 mm

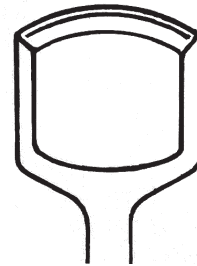

FIG. 6

**035-800-006** 22 mm



trapezförmig gefenstert  
 trapezoidal fenestrated  
 fenestrado trapecialmente  
 fenestrato a forma di trapezio

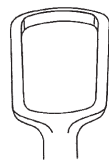

FIG. 1  
**035-810-001** 10 mm

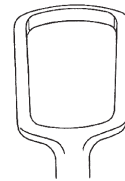

FIG. 2  
**035-810-002** 14 mm

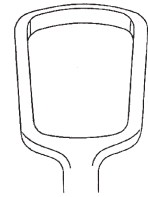

FIG. 3  
**035-810-003** 16 mm

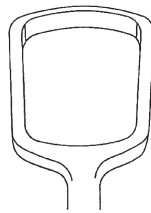

FIG. 4  
**035-810-004** 18 mm

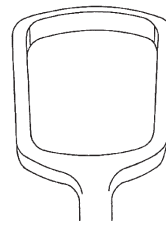

FIG. 5  
**035-810-005** 20 mm

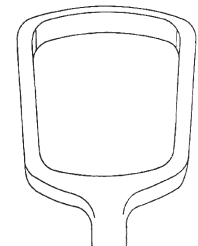

FIG. 6  
**035-810-006** 22 mm

**BECKMANN**

**035-810-001 - 035-810-006** 22,0 cm / 8<sup>3</sup>/<sub>4</sub>"



FIG. 1  
**035-820-001** 16 mm



FIG. 2  
**035-820-002** 18 mm



FIG. 3  
**035-820-003** 20 mm



FIG. 4  
**035-820-004** 23 mm

**BARNHILL**

**035-820-001 - 035-820-004** 21,0 cm / 8<sup>1</sup>/<sub>4</sub>"



035

Ringmesser  
Adenoid Currettes  
Cuchillos para adenoides  
Coltelli per vegetazioni adenoidee



FIG. 1  
035-830-001

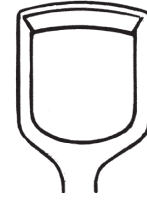

FIG. 2  
035-830-002

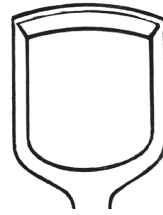

FIG. 3  
035-830-003

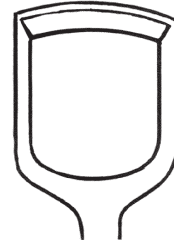

FIG. 4  
035-830-004

**ST. CLAIR-THOMSON**

035-830-001 - 035-830-004 21,0 cm / 8 1/4"

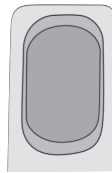

FIG. 1  
035-840-001

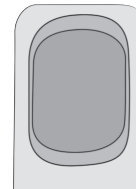

FIG. 2  
035-840-002

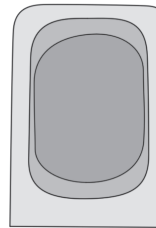

FIG. 3  
035-840-003

mit gelochter Klinge  
with perforated blade  
con hoja perforada  
con lama forato

Ersatzklingen  
Spare Blades  
Hojas de repuesto  
Lame di ricambio

FIG. 1  
035-841-001

FIG. 2  
035-841-002

FIG. 3  
035-841-003

**LA FORCE**

035-840-001 - 035-840-003 25,0 cm / 10"



**EICKEN-KILLIAN**

**035-851-140** 14,0 cm / 5 1/2"



**GUILEN**

**035-857-190** 19,0 cm / 7 1/2"

Saugraspatorium  
 Suction Raspatorium  
 Legra de succión  
 Raspatorio con aspiratore



**SIEBENMANN**

<b>035-855-015</b>	15,0 cm / 6"	Ø 1,5 mm
<b>035-855-017</b>	15,0 cm / 6"	Ø 1,7 mm
<b>035-855-020</b>	15,0 cm / 6"	Ø 2,0 mm
<b>035-855-025</b>	15,0 cm / 6"	Ø 2,5 mm
<b>035-855-030</b>	15,0 cm / 6"	Ø 3,0 mm



**RITTER-HALLE**

<b>035-859-025</b>	14,5 cm / 5 3/4"	Ø 2,5 mm
<b>035-859-030</b>	14,5 cm / 5 3/4"	Ø 3,0 mm
<b>035-855-040</b>	14,5 cm / 5 3/4"	Ø 4,0 mm
<b>035-859-050</b>	14,5 cm / 5 3/4"	Ø 5,0 mm