

032

Ophthalmologie
Ophthalmology
Oftalmología
Ophtalmologia

ungeeicht
 un calibrated
 no calibrado
 non calibrato



SCHIOETZ

032-010-000

mit gerader Skala
 with straight scale
 con escala recta
 con scala retta

032-011-000

mit gebogener Skala
 with curved scale
 con escala inclinada
 con scala inclinata

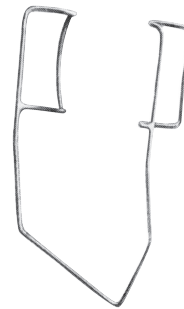

BARRAQUER (COLIBRI)

032-021-003 3,0 cm / 1 1/4"

für Kinder
 for children
 para niños
 per bambini

BARRAQUER (COLIBRI)

032-021-004 4,0 cm / 1 1/2"

für Erwachsene
 for adults
 para adultos
 per adulti



BOWMAN

032-023-007 7,0 cm / 2 3/4"

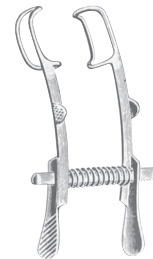

MELLINGER

032-051-005 5,0 cm / 2"

für Kinder
 for children
 para niños
 per bambin

MELLINGER

032-051-007 7,0 cm / 2 3/4"

für Erwachsene
 for adults
 para adultos
 per adulti



MELLINGER-AXENFELD

032-053-007 7,0 cm / 2 3/4"

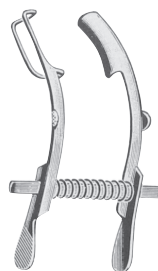

MELLINGER-AXENFELD

032-055-007 7,0 cm / 2 3/4"



CASTROVIEJO

032-059-008 8,0 cm / 3 1/8"



DESMARRES
032-100-009 13,0 cm / 5¹/₈"

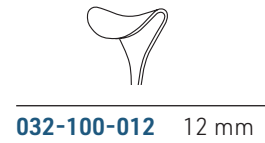

032-100-012 12 mm



032-100-014 14 mm

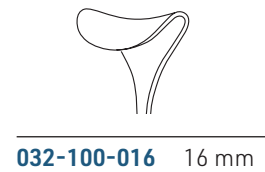

032-100-016 16 mm

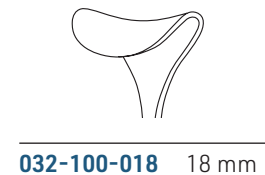

032-100-018 18 mm



DESMARRES
032-100-012 - 032-100-018 13,0 cm / 5¹/₈"



032-102-012 12 mm



032-102-014 14 mm



032-102-016 16 mm



032-102-018 18 mm



DESMARRES
032-102-012 - 032-102-018 13,0 cm / 5¹/₈"



JAEGER
032-110-110 11,0 cm / 4¹/₂"



032

Starmesser
Cataract Knives
Cuchillos para catarata
Coltelli per cataratta

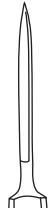

FIG.0
032-120-000

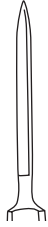

FIG.1
032-120-001

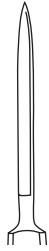

FIG.2
032-120-002



FIG.3
032-120-003

GRAEFE

032-120-000 - 032-120-003 13,0 cm / 5 1/8"



FIG.1
032-150-001



FIG.2
032-150-002

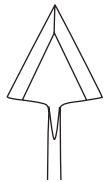

FIG.3
032-150-003



JAEGER-GRIESHABER

032-150-001 - 032-150-003



032-160-001



032-160-002



032-160-003



KNAPP

032-160-001 - 032-160-003

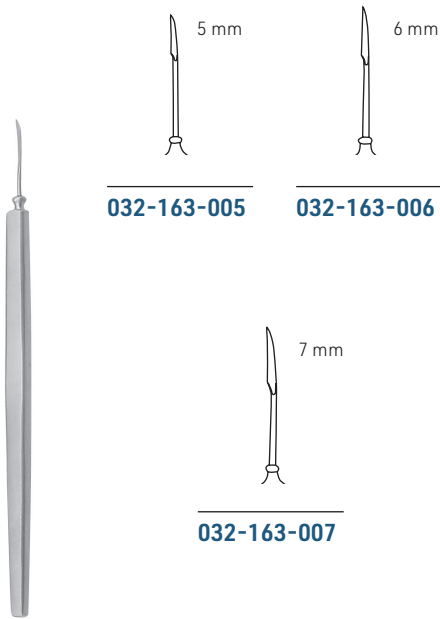

5 mm
 032-163-005

6 mm
 032-163-006

7 mm
 032-163-007

ZIEGLER

032-163-005 - 032-163-007 13,0 cm / 5 1/8"

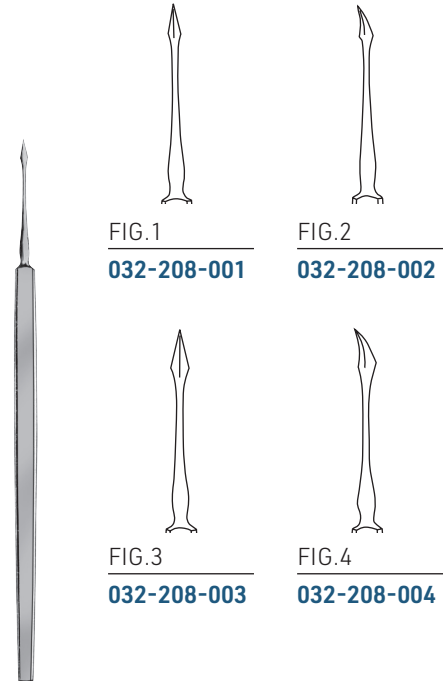

FIG.1
 032-208-001

FIG.2
 032-208-002

FIG.3
 032-208-003

FIG.4
 032-208-004

032-208-001 - 032-208-004 13,0 cm / 5 1/8"

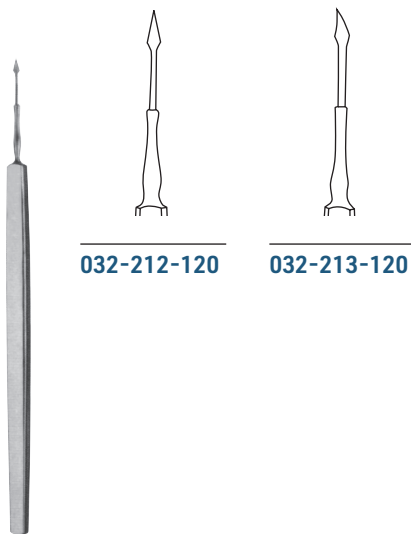

032-212-120

032-213-120

BOWMAN

032-212-120 - 032-213-120 12,0 cm / 4 3/4"

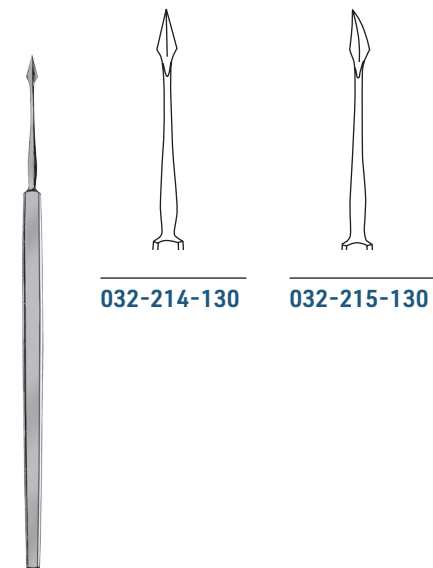

032-214-130

032-215-130

032-214-130 - 032-215-130 13,0 cm / 5 1/8"



032

Fremdkörper-Instrumente, Cystotome
 Foreign Body Instruments, Cystotomes
 Instrumentos para cuerpos extraños, Quistótomos
 Strumenti per corpi estranei, Cistitome



WALTON
032-232-120



WALTON
032-234-120



MEYER
032-236-120

032-232-120 - 032-236-120 12,0 cm / 4³/₄"



STANDARD
032-244-120

Fremdkörperschlinge und Magnet
 in Umsteckhülse

Foreign Body Remover and Magnetic
 Eye Probe, in reversible handle

Lazo para cuerpos extraños e Imán,
 en mango reversible

Laccio per corpi estranei e Calamita,
 in manico reversibile



032-246-130



032-247-130

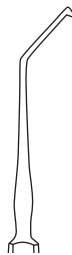

032-249-130

GRAEFE
032-246-130 - 032-249-130 13,0 cm / 5¹/₈"



032-253-120
 scharf
 shap
 agudo
 acuto



032-255-120
 stumpf
 blunt
 romo
 smusso

GRAEFE
032-253-120 - 032-255-120 12,0 cm / 4³/₄"

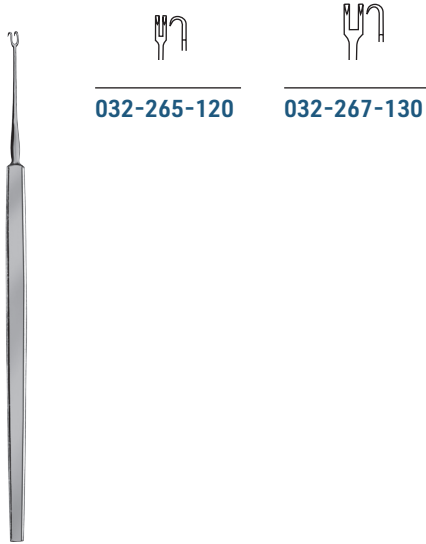

032-265-120

032-267-130

GUTHRIE

032-265-120 12,0 cm / 4³/₄"
 032-267-130 13,0 cm / 5¹/₈"

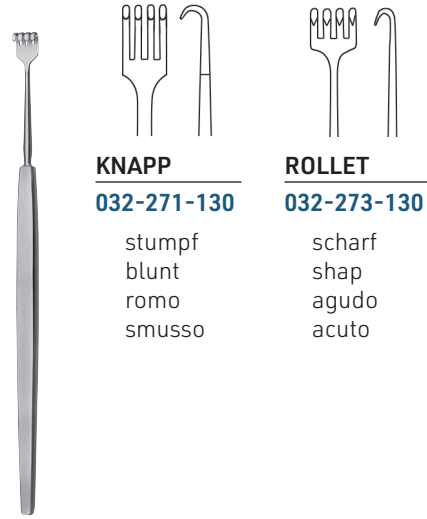

KNAPP
 032-271-130

ROLLET
 032-273-130

stumpf
 blunt
 romo
 smusso

scharf
 shap
 agudo
 acuto

032-271-130 - 032-273-130 13,0 cm / 5¹/₈"

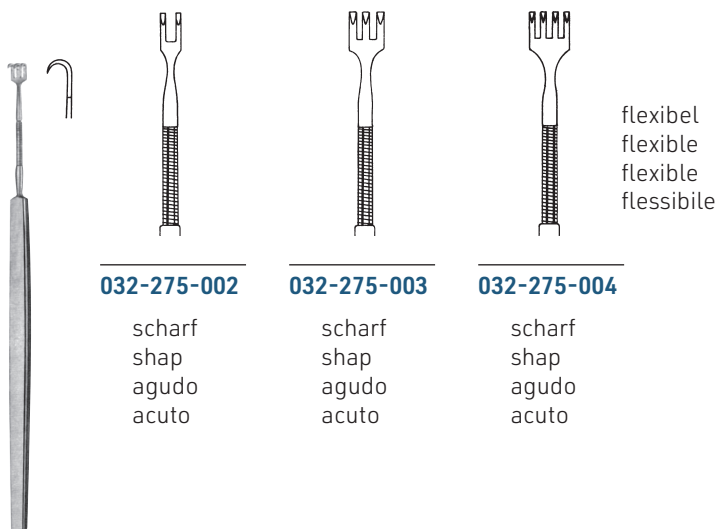

032-275-002

032-275-003

032-275-004

scharf
 shap
 agudo
 acuto

scharf
 shap
 agudo
 acuto

scharf
 shap
 agudo
 acuto

flexibel
 flexible
 flexible
 flessibile

KNAPP-ROLLET

032-275-002 - 032-275-004 13,0 cm / 5¹/₈"



032

Feine Wundhäkchen
Fine Hooklets
Ganchos y Ganchitos finos
Uncini sottile



032-277-002

scharf
shap
agudo
acuto

032-279-002

stumpf
blunt
romo
smusso

032-281-003

scharf
shap
agudo
acuto

032-283-003

stumpf
blunt
romo
smusso

AXENFELD

032-277-002 - 032-283-003

15,0 cm / 6"

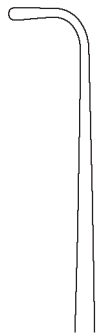
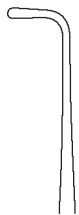
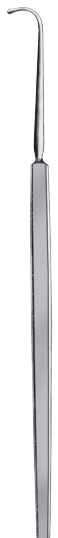

032-297-130

032-297-140

032-297-150

GRAEFE

032-297-130 13,0 cm / 5 1/8"
032-297-140 14,0 cm / 5 1/2"
032-297-150 15,0 cm / 6"

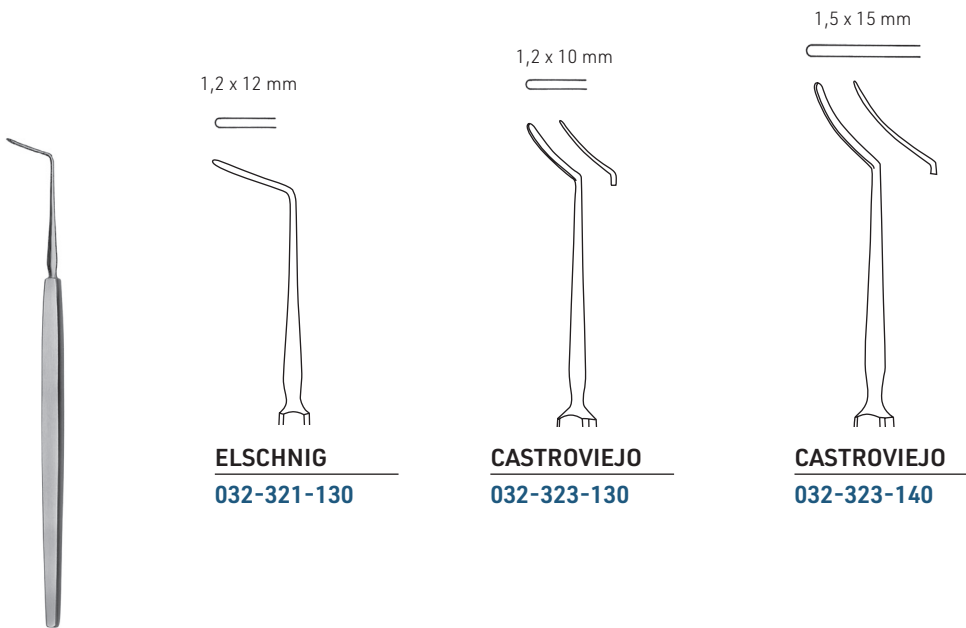

ELSCHNIG
 032-321-130

CASTROVIEJO
 032-323-130

CASTROVIEJO
 032-323-140

032-321-130 - 032-323-130 13,0 cm / 5 1/8"
 032-323-140 14,0 cm / 5 1/2"

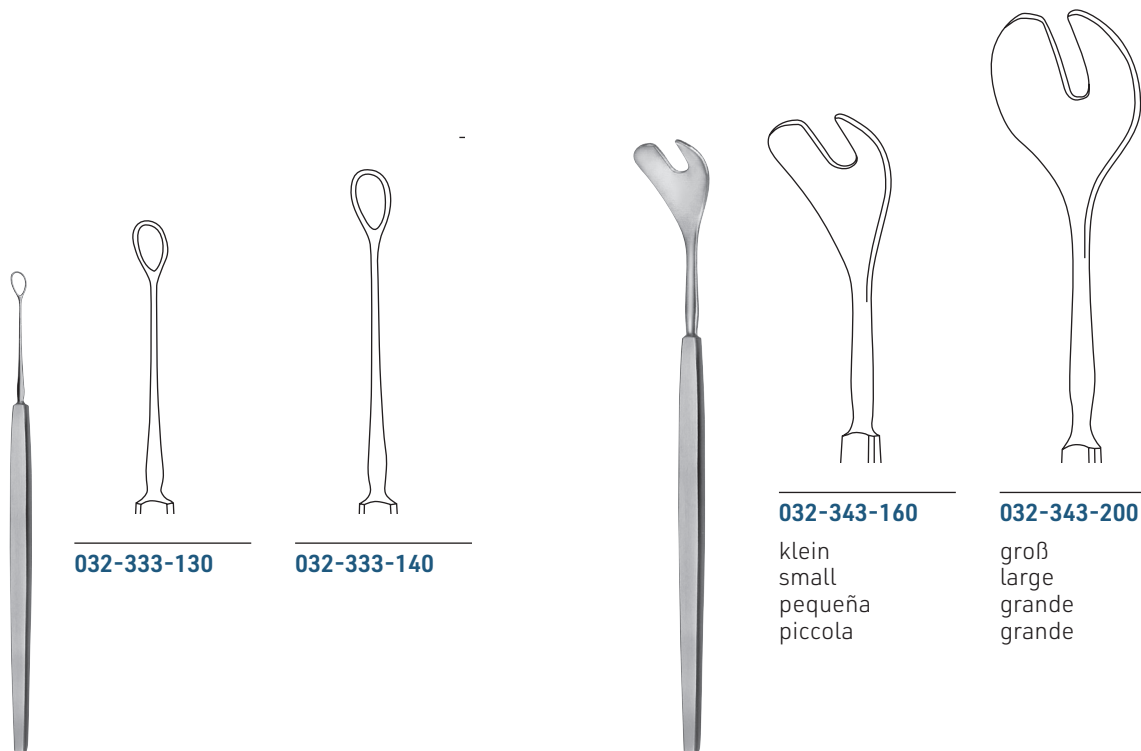

032-333-130

032-333-140

032-343-160

032-343-200

klein
 small
 pequeña
 piccola

groß
 large
 grande
 grande

WEBER

032-333-130 13,0 cm / 5 1/8"
 032-333-140 14,0 cm / 5 1/2"

WELLS

032-343-160
 032-343-200



032

Chalationslöffel
Chalazion Curettes
Cucharillas para chalazión
Cucchiai per calazio

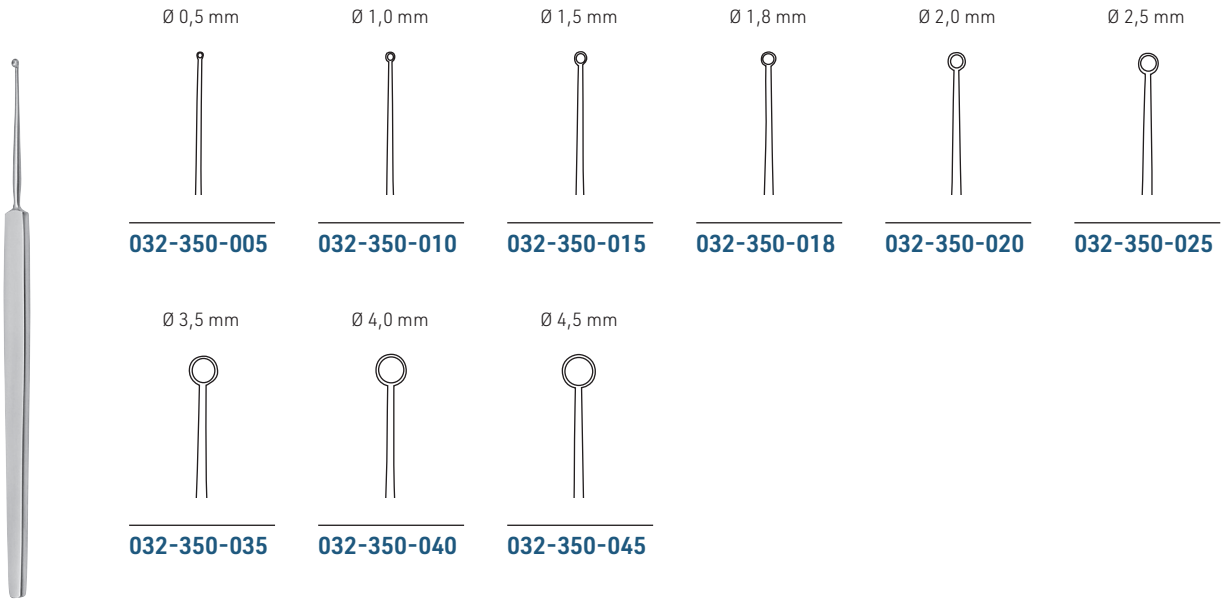

MEYHOEFER

032-350-005 - 032-350-045

13,0 cm / 5 1/8"

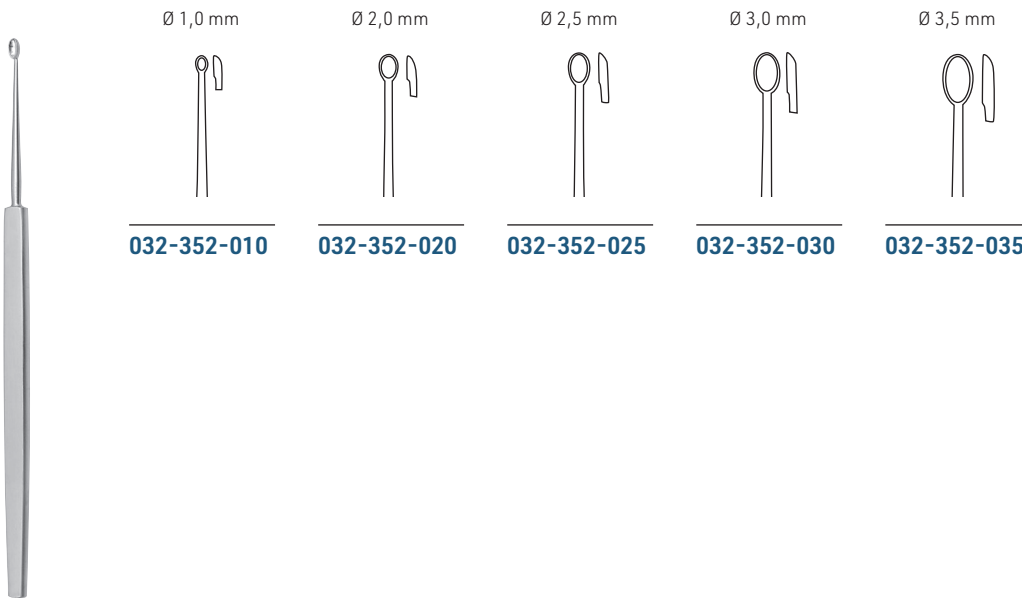

HEBRA

032-352-010 - 032-352-035

13,0 cm / 5 1/8"

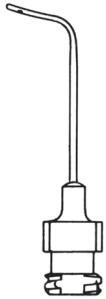

CASTROVIEJO
032-361-010 1,0 mm

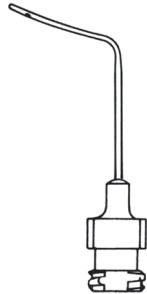

CASTROVIEJO
032-361-015 1,5 mm

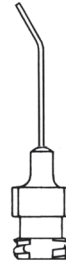

LUER LOCK
032-363-027 27 Gauch

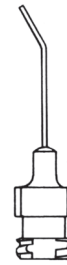

LUER LOCK
032-363-030 30 Gauch



032-420-010
 Griff allein
 Handle only
 Mango suelto
 Manico solo

Ø 1,5 mm



032-420-015

Ø 2,0 mm



032-420-020

ELLIOT

032-420-000

Satz komplett bestehend aus:

- 1 Griff Art.-Nr. 032-420-010
- 2 Trephinen Ø 1,5 mm, Art.-Nr. 032-420-015
- 2 Trephinen Ø 2,0 mm, Art.-Nr. 032-420-020

Set complete consisting of:

- 1 Handle Ref.-No. 032-420-010
- 2 Trephines Ø 1,5 mm, Ref.-No. 032-420-015
- 2 Trephinen Ø 2,0 mm, Ref.-No. 032-420-020

Juego completo compuesto de:

- 1 Griff Ref.-No. 032-420-010
- 2 Trépanos Ø 1,5 mm, Ref.-No. 032-420-015
- 2 Trépanos Ø 2,0 mm, Ref.-No. 032-420-020

Set completo composto da:

- 1 Manico Ref.-No. 032-420-010
- 2 Trapani Ø 1,5 mm, Ref.-No. 032-420-015
- 2 Trapani Ø 2,0 mm, Ref.-No. 032-420-020



032

Stanzen, Meißel, Meßzirkel
Punches, Chisels, Measuring Caliper
Pinzas saca-bocados, Cinceles, Compases para medición
Pinze tagliante, Sgorbie, compassi per misurare



HOLTH

032-441-090 9,0 cm / 3 1/2"



WEST

032-442-160 16,0 cm / 6 1/4"



WEST

032-444-160 16,0 cm / 6 1/4"

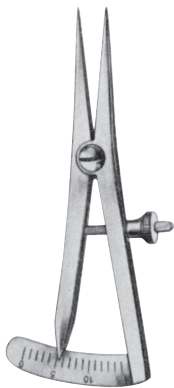

CASTROVIEJO

032-450-015

Meßbereich: 15 mm
Measuring Range: 15 mm
Alcance de medición: 15 mm
Campo di misura: 15 mm

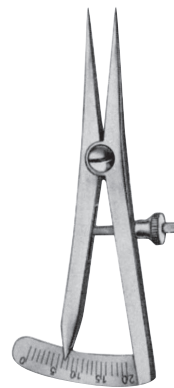

CASTROVIEJO

032-450-020

Meßbereich: 20 mm
Measuring Range: 20 mm
Alcance de medición: 20 mm
Campo di misura: 20 mm

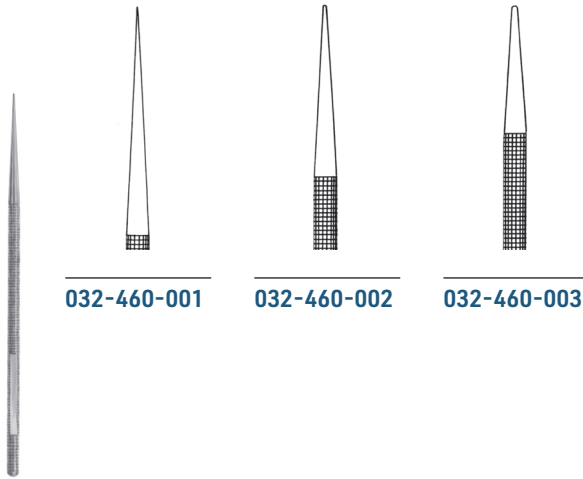

WILDER
 032-460-001 - 032-460-003

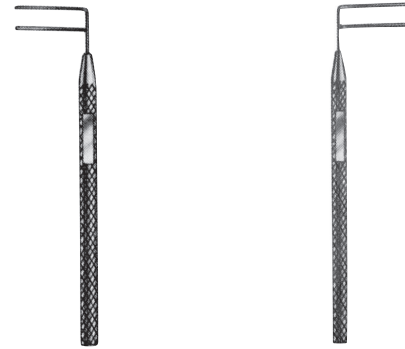

HARMS
 032-465-001

links
 left
 izquierda
 sinistra

HARMS
 032-465-002

rechts
 right
 derecha
 destra



zylindrisch/geknöpft
 cylindrical/pointed
 cilíndrico/abotonado
 cilindrico/abbottonato

Neusilber
 German silver
 plata alemana
 in argerto

BOWMAN FIG.

032-470-000	0/0	0,8 mm
032-470-011	1/1	0,9 mm
032-470-022	2/2	1,1 mm
032-470-033	3/3	1,3 mm
032-470-044	4/4	1,4 mm
032-470-055	5/5	1,5 mm
032-470-066	6/6	1,6 mm
032-470-077	7/7	1,8 mm
032-470-088	8/8	1,9 mm



zylindrisch
 cylindrical
 cilíndrico
 cilindrico

Neusilber
 German silver
 plata alemana
 in argerto

BOWMAN FIG.

032-472-000	00/0	0,7/0,8 mm
032-472-001	0/1	0,8/0,9 mm
032-472-012	1/2	0,9/1,1 mm
032-472-023	2/3	1,1/1,3 mm
032-472-034	3/4	1,3/1,4 mm
032-472-045	4/5	1,4/1,5 mm
032-472-056	5/6	1,5/1,6 mm
032-472-067	6/7	1,6/1,8 mm
032-472-078	7/8	1,8/1,9 mm



geknöpft
 pointed
 abotonado
 abbottonato

Neusilber
 German silver
 plata alemana
 in argerto

BOWMAN FIG.

032-474-000	00/0	0,7/0,8 mm
032-474-001	0/1	0,8/0,9 mm
032-474-012	1/2	0,9/1,1 mm
032-474-023	2/3	1,1/1,3 mm
032-474-034	3/4	1,3/1,4 mm
032-474-045	4/5	1,4/1,5 mm
032-474-056	5/6	1,5/1,6 mm
032-474-067	6/7	1,6/1,8 mm
032-474-078	7/8	1,8/1,9 mm



032

Doppelinstrumente
Double-ended Instruments
Instrumentos dobles
Strumenti doppio

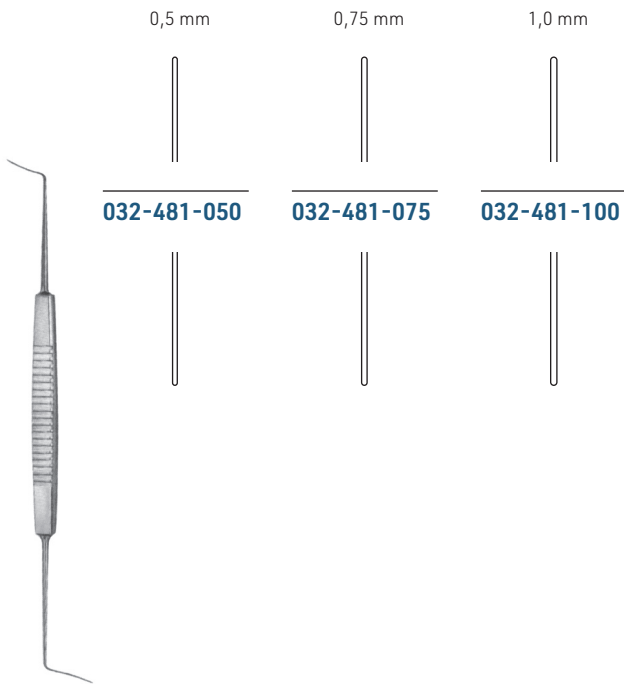

CASTROVIEJO

032-481-050 - 032-481-100



Flachmeißel
Chisel
Cincel
Scalpello

DIX

032-490-120 12,0 cm / 4³/₄"



Hohlmeißel
Gouge
Gubia
Sgorbie

DIX

032-492-120 12,0 cm / 4³/₄"



Flachmeißel
Chisel
Cincel
Scalpello

032-494-130 13,0 cm / 5¹/₈"

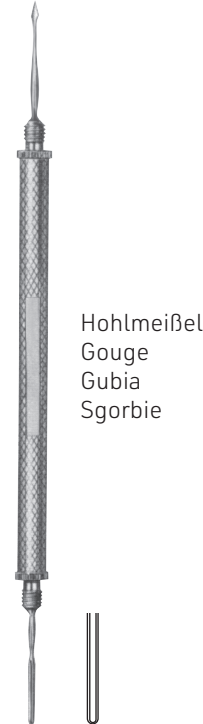

Hohlmeißel
Gouge
Gubia
Sgorbie

032-496-130 13,0 cm / 5¹/₈"

1,0 mm

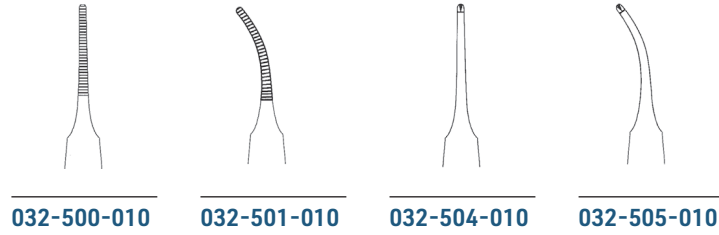

GRAEFE

032-500-010 - 032-505-010 7,0 cm / 2³/₄"

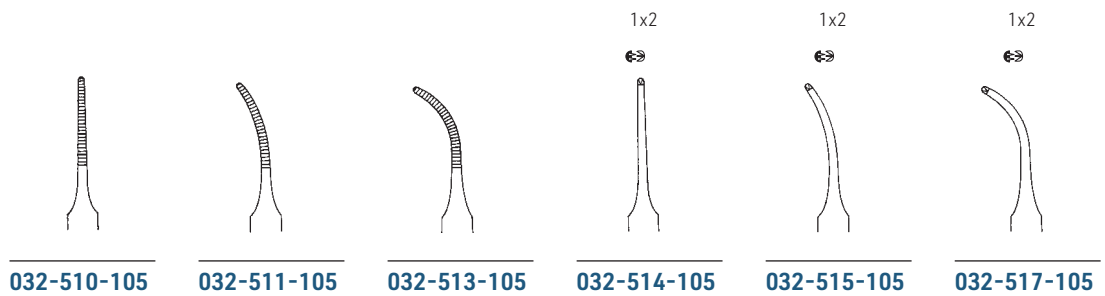

STEVENS

032-510-105 - 032-517-105 10,5 cm / 4¹/₂"



032

Irispinzetten, Fixierpinzetten
Iris Forceps, Fixation Forceps
Pinzas para iris, Pinzas de fijación
Pinze per iride, Pinze per fissare

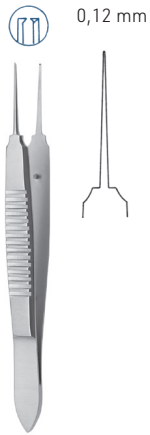

MOD. BONN

032-542-070 7,0 cm / 2³/₄"
032-542-100 10,0 cm / 4"



BISHOP-HARMAN

032-544-085 - 032-550-085 8,5 cm / 3¹/₂"

0,8 mm

032-544-085

1x2



032-546-085

0,5 mm

032-548-085

fein
fine
fina
fina

1x2



032-550-085

fein
fine
fina
fina

1x2 0,4 mm

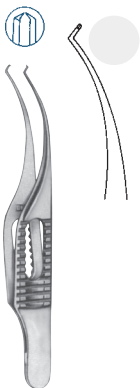

BARRAQUER-KATZIN

032-553-070 7,0 cm / 2³/₄"

1x2 0,12 mm

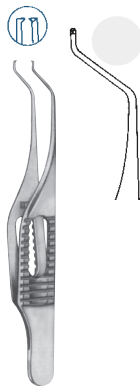

TROUTMAN (COLIBRI)

032-555-075 7,5 cm / 3"

1x2 0,12 mm

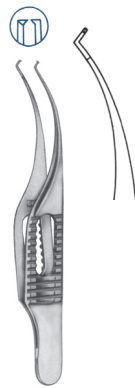

BARRAQUER (COLIBRI)

032-557-070 7,0 cm / 2³/₄"

1x2 0,12 mm

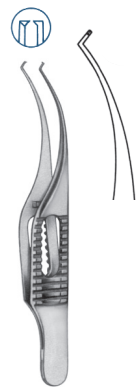

BARRAQUER-KATZIN (COLIBRI)

032-559-070 7,0 cm / 2³/₄"

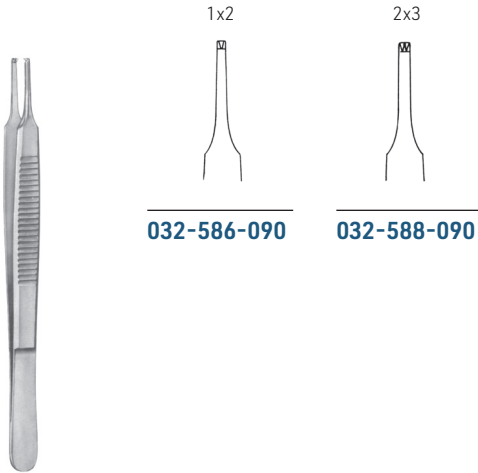

LESTER

032-586-090 - 032-588-090 9,0 cm / 3 1/2"

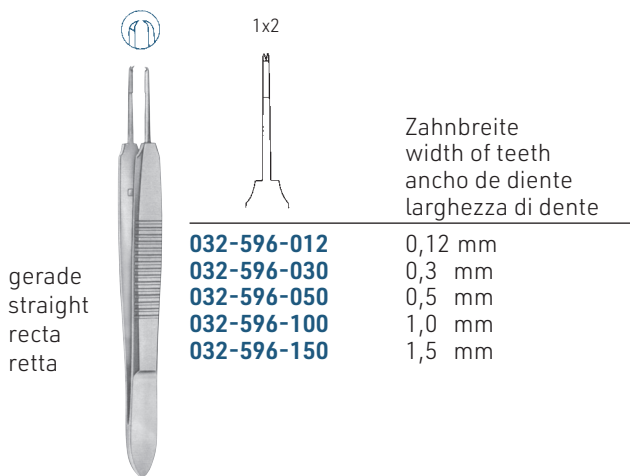

gerade
 straight
 recta
 retta

CASTROVIEJO

032-596-012 - 032-596-150 10,0 cm / 4"

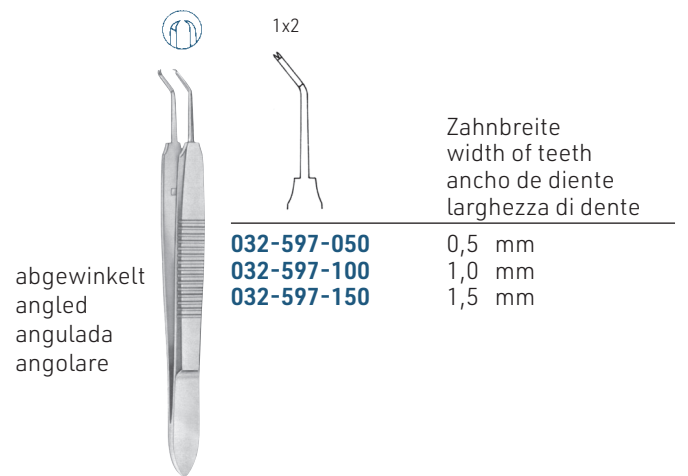

abgewinkelt
 angled
 angulada
 angolare

CASTROVIEJO

032-597-050 - 032-597-150 10,0 cm / 4"



032

Nahtpinzetten,
Suture Forceps
Pinzas para sutura
Pinze per sutura

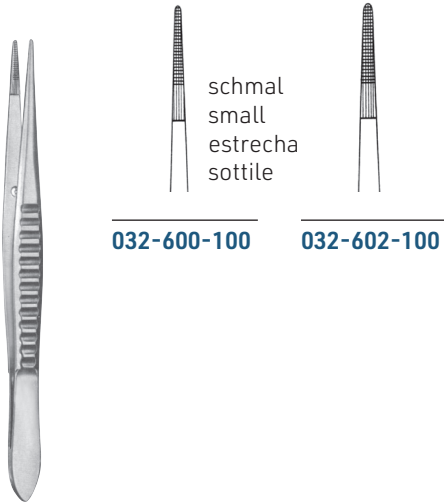

schmal
small
estrecha
sottile

032-600-100

032-602-100

BONACCOLTO

032-600-100 - 032-602-100

10,0 cm / 4"

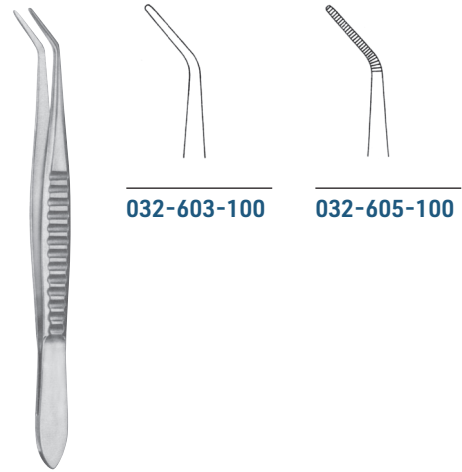

032-603-100

032-605-100

NUGENT

032-603-100 - 032-605-100

10,0 cm / 4"



SNELLEN

032-625-100

10,0 cm / 4"



SNELLEN

032-627-100

10,0 cm / 4"

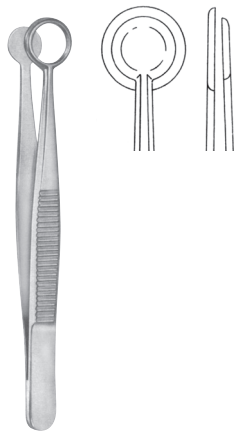

AYER

032-630-090 9,0 cm / 3 1/2"

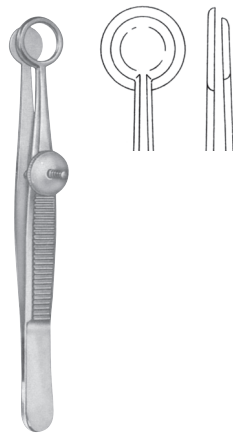

AYER

032-632-090 9,0 cm / 3 1/2"

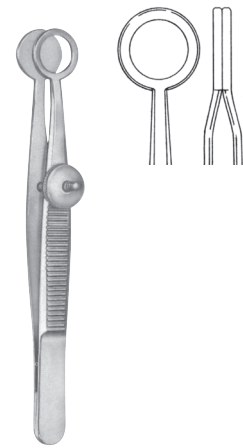

LAMBERT

032-634-090 9,0 cm / 3 1/2"



DESMARRES

032-636-001 - 032-636-003 9,0 cm / 3 1/2"

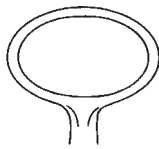

032-636-001

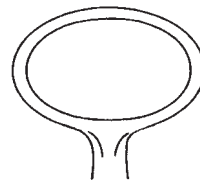

032-636-002

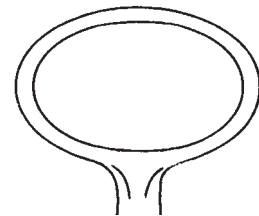

032-636-003



032

Mikro-Scheren
Micro Scissors
Micro Tijeras
Micro Forbici



links
left
izquierda
sinistra

KATZIN-BARRAQUER

032-701-100 10,0 cm / 4"



rechts
right
derecha
destro

KATZIN-BARRAQUER

032-703-100 10,0 cm / 4"



032-704-100



032-705-100

032-704-100 - 032-705-100

10,0 cm / 4"



CASTROVIEJO

032-707-100 10,0 cm / 4"



CASTROVIEJO

032-709-100 10,0 cm / 4"



AEBLI

032-711-100 10,0 cm / 4"



032-720-120



032-722-120



032-724-120



032-735-110



032-737-110

spitz
pointed
aguda
acuto

stumpf
blunt
roma
smusso

NOYES

032-720-120 - 032-724-120

12,0 cm / 4³/₄"

WESTCOTT

032-735-110 - 032-737-110

11,0 cm / 4¹/₂"

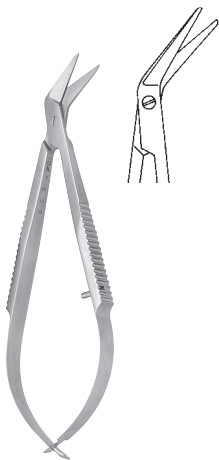

CASTROVIEJO

032-743-090 9,0 cm / 3¹/₂"



032-751-100



032-753-100

spitz
pointed
aguda
acuto

stumpf
blunt
roma
smusso

CASTROVIEJO

032-751-100 - 032-753-100 10,0 cm / 4"



032

Iridektomiescheren,
Iridectomy Scissors
Tijeras para iridectomia
Forbici per iridectomia



032-756-080



032-757-080

VANNAS

032-756-080 - 032-757-080

8,0 cm / 3 1/4"



032-760-085



032-761-085



032-763-085

VANNAS-MOD. TÜBINGEN

032-760-085 - 032-763-085

8,5 cm / 3 1/2"



032-771-005



032-771-007

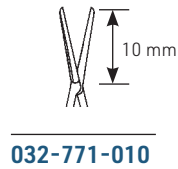

032-771-010

BARRAQUER

032-771-005 - 032-771-010

5,5 cm / 2 1/4"

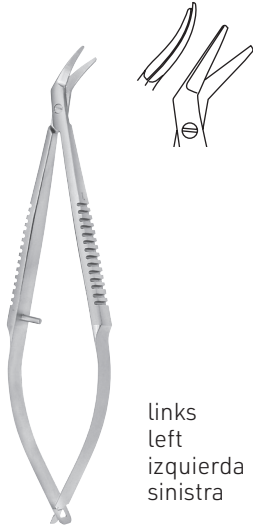

links
left
izquierda
sinistra

CASTROVIEJO

032-781-100 10,0 cm / 4"

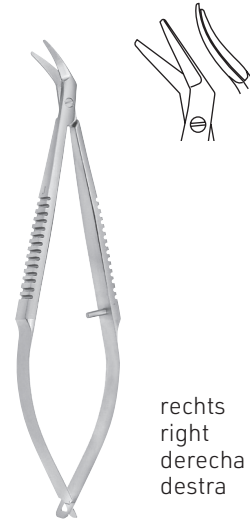

rechts
right
derecha
dextra

CASTROVIEJO

032-783-100 10,0 cm / 4"



links
left
izquierda
sinistra

CASTROVIEJO

032-785-110 11,0 cm / 4 1/2"



rechts
right
derecha
dextra

CASTROVIEJO

032-787-110 11,0 cm / 4 1/2"