

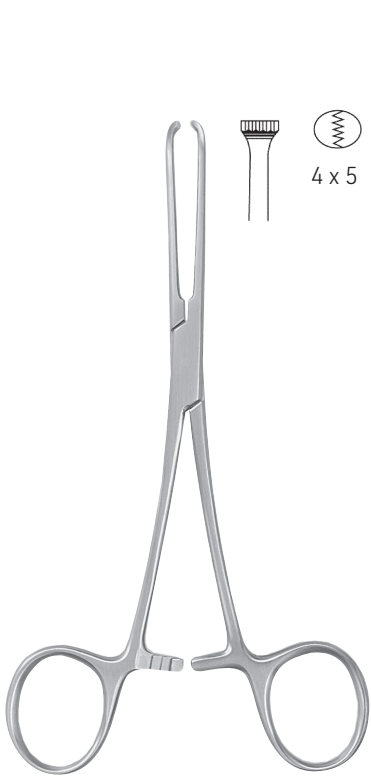

027

Magen, Darm, Urologie  
Stomach, Intestines, Urology  
Estómago, Intestinos,  
Urología  
Stomaco, Intestini, Urologia

Darm- und Gewebefassungen  
 Intestinal and Tissue Grasping Forceps  
 Pinzas intestinales y para tejidos  
 Pinze da presa per intestino e tessuti



**ALLIS-BABY**

- 027-100-120** 12,0 cm / 4<sup>3</sup>/<sub>4</sub>"
- 027-100-140** 14,0 cm / 5<sup>1</sup>/<sub>2</sub>"



**ALLIS**

- 027-110-150** 15,0 cm / 6"
- 027-110-190** 19,0 cm / 7<sup>1</sup>/<sub>2</sub>"



**ALLIS**

- 027-120-150** 15,0 cm / 6"
- 027-120-190** 19,0 cm / 7<sup>1</sup>/<sub>2</sub>"
- 027-120-220** 22,0 cm / 8<sup>3</sup>/<sub>4</sub>"
- 027-120-250** 25,0 cm / 9<sup>3</sup>/<sub>4</sub>"

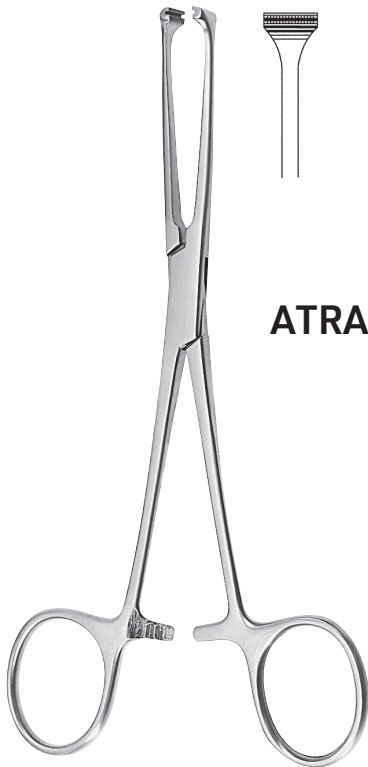

**ATRAUMA**

**ALLIS**

- 027-122-160** 16,0 cm / 6<sup>1</sup>/<sub>4</sub>"
- 027-122-200** 20,0 cm / 8"
- 027-122-250** 25,0 cm / 9<sup>3</sup>/<sub>4</sub>"
- 027-122-300** 30,0 cm / 11<sup>1</sup>/<sub>4</sub>"



**ALLIS-ADAIR**

- 027-130-155** 15,5 cm / 6"

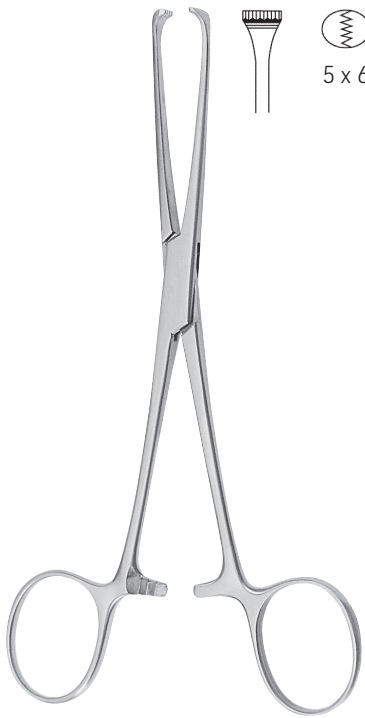

**BOYS-ALLIS**

**027-132-150** 15,0 cm / 6"



**JUDD-ALLIS**

**027-134-150** 15,0 cm / 6"  
**027-134-190** 19,0 cm / 7½"



**THOMS-ALLIS**

**027-140-200** 20,0 cm / 8"



**ALLIS**

**027-142-200** 20,0 cm / 8"

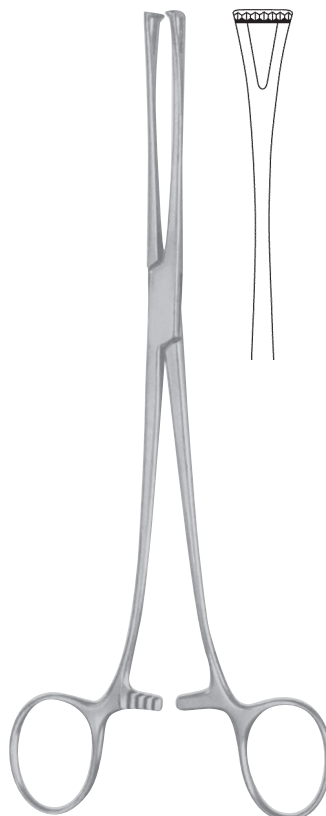

**LOCKWOOD-ALLIS**

**027-144-200** 20,0 cm / 8"



**WILLIAMS**

**027-146-160** 16,0 cm / 6¼"



027

Darm- und Gewebefasszangen  
 Intestinal and Tissue Grasping Forceps  
 Pinzas intestinales y para tejidos  
 Pinze da presa per intestino e tessuti



  
 2 x 3

**LITTLEWOOD**

**027-152-185** 18,5 cm / 7 1/4"

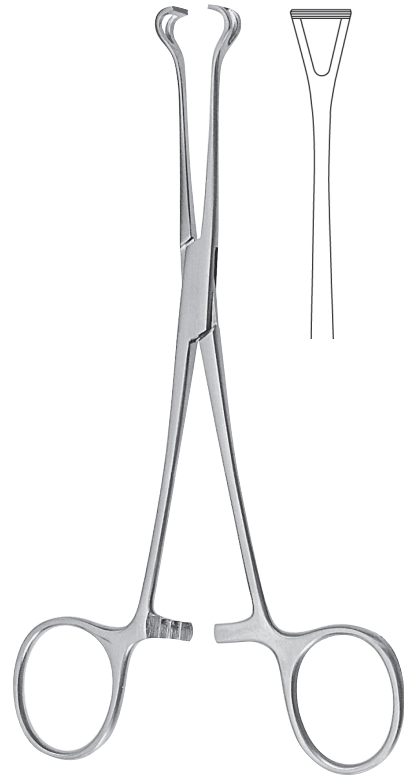

**BABCOCK**

- 027-160-140** 14,0 cm / 5 1/2"
- 027-160-160** 16,0 cm / 8"
- 027-160-180** 18,0 cm / 7"
- 027-160-200** 20,0 cm / 8"
- 027-160-240** 24,0 cm / 9 1/2"

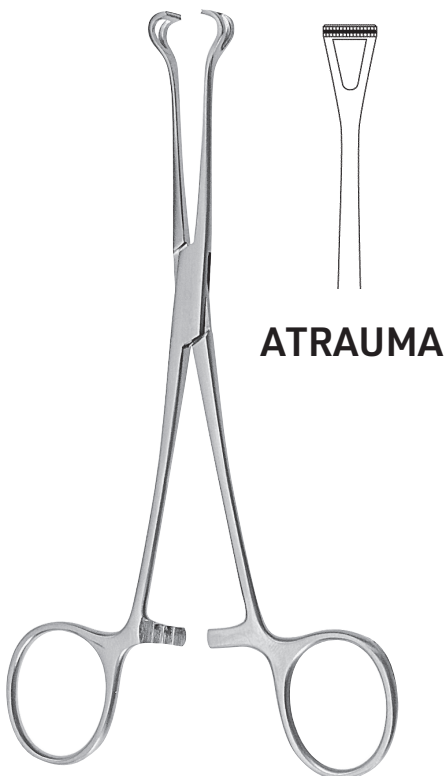

**ATRAUMA**

**BABCOCK**

- 027-162-160** 16,0 cm / 6 1/4"
- 027-162-200** 20,0 cm / 8"



**BABCOCK-TC**

- 027-164-160** 16,0 cm / 6 1/4"
- 027-164-200** 20,0 cm / 8"



**DUVAL**

**027-170-180** 18,0 cm / 7"  
**027-170-200** 20,0 cm / 8"

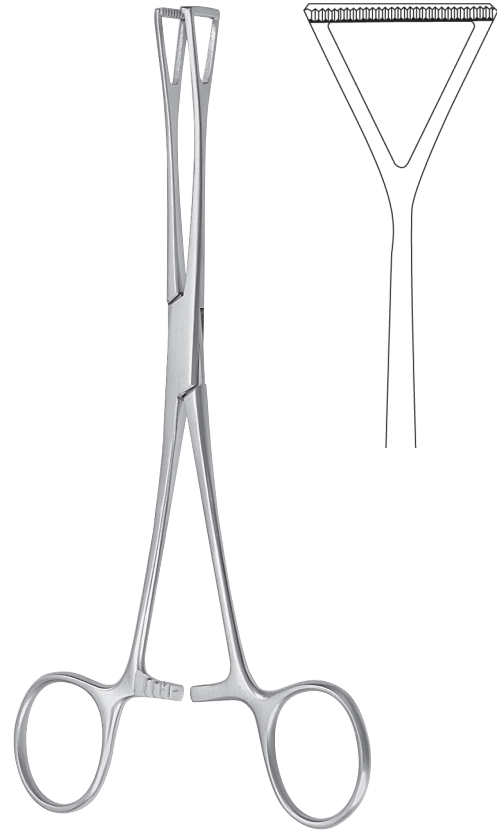

**DUVAL**

**027-172-200** 20,0 cm / 8"  
**027-172-230** 23,0 cm / 9"



**DUVAL-TC**

**027-174-200** 20,0 cm / 8"



**ALLEN**

**027-200-155** 15,5 cm / 6"



027

Darm- und Gewebefasszangen  
Intestinal and Tissue Grasping Forceps  
Pinzas intestinales y para tejidos  
Pinze da presa per intestino e tessuti



027-210-180

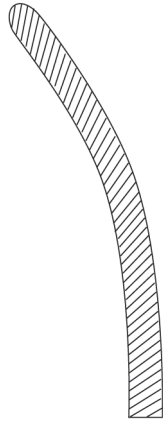

027-211-180

**BABY-DOYEN**

027-210-180 - 027-211-180

18,0 cm / 7"



027-214-210  
027-214-230

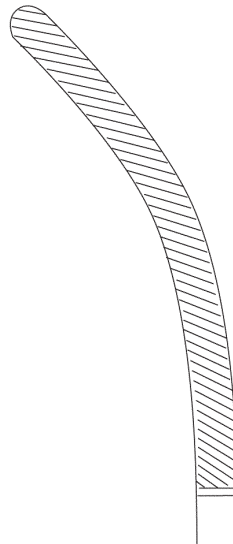

027-215-210  
027-215-230

**DOYEN**

027-214-210 - 027-215-210  
027-214-230 - 027-215-230

21,0 cm / 8<sup>1</sup>/<sub>4</sub>"  
23,0 cm / 9"

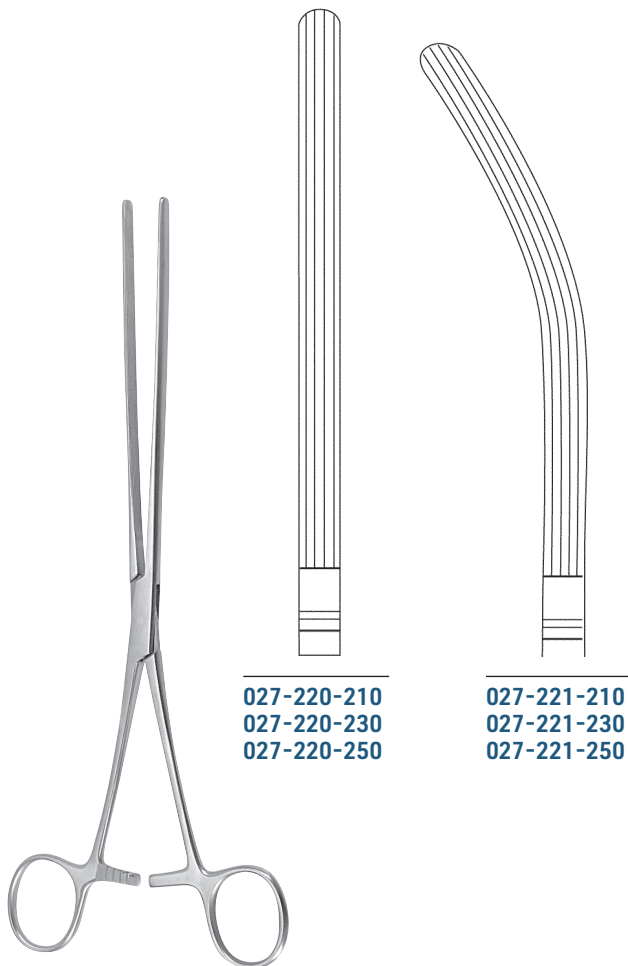

027-220-210  
027-220-230  
027-220-250

027-221-210  
027-221-230  
027-221-250

**MAYO-ROBSON**

027-220-210 - 027-221-210	21,0 cm / 8 <sup>1</sup> / <sub>4</sub> "
027-220-230 - 027-221-230	23,0 cm / 9"
027-220-250 - 027-221-250	25,0 cm / 9 <sup>3</sup> / <sub>4</sub> "

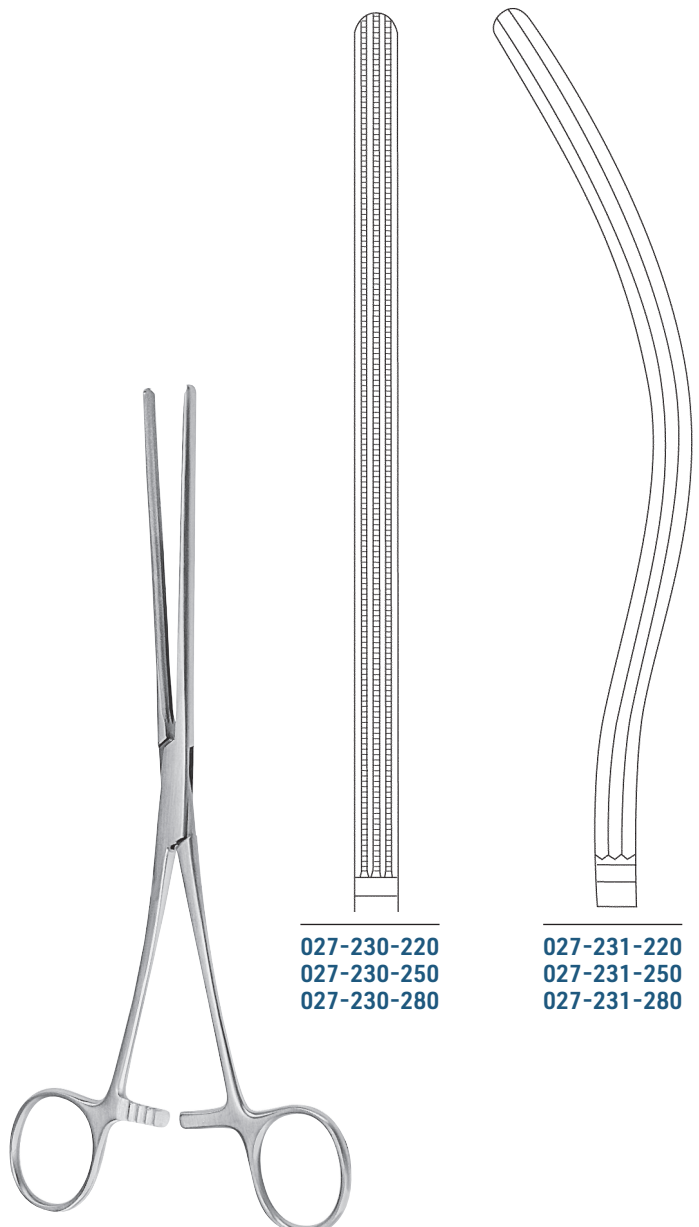

027-230-220  
027-230-250  
027-230-280

027-231-220  
027-231-250  
027-231-280

**KOCHER**

027-230-220 - 027-231-220	22,0 cm / 8 <sup>3</sup> / <sub>4</sub> "
027-230-250 - 027-231-250	25,0 cm / 9 <sup>3</sup> / <sub>4</sub> "
027-230-280 - 027-231-280	28,0 cm / 11"



027

Klemmen  
Clamps  
Pinzas  
Pinze



027-232-330

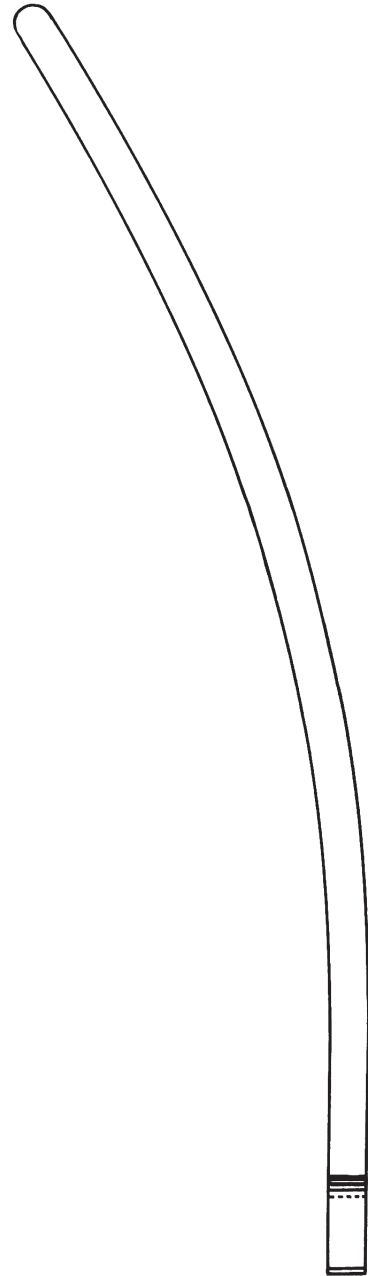

027-233-330

**SCUDDER**

027-232-330 - 027-233-330

33,0 cm / 13"



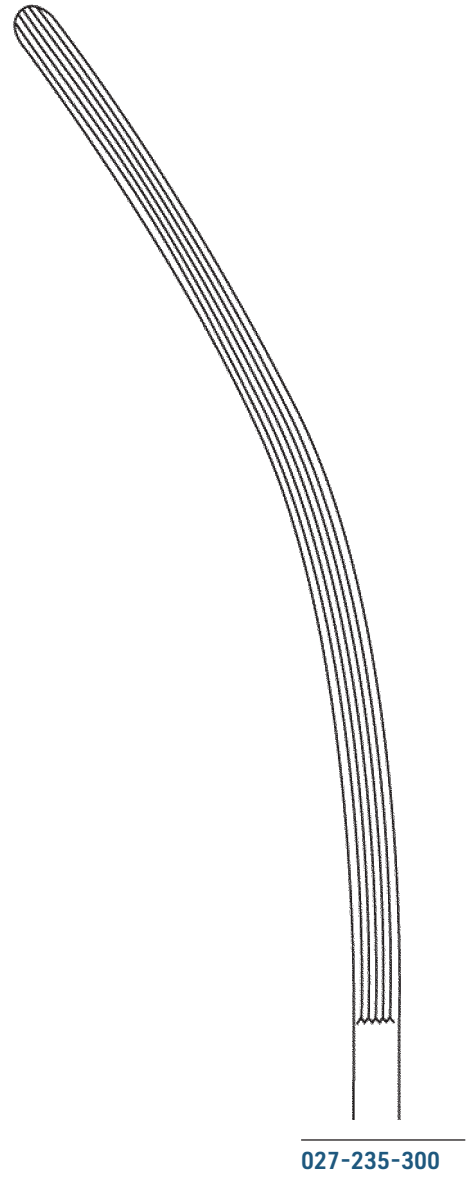
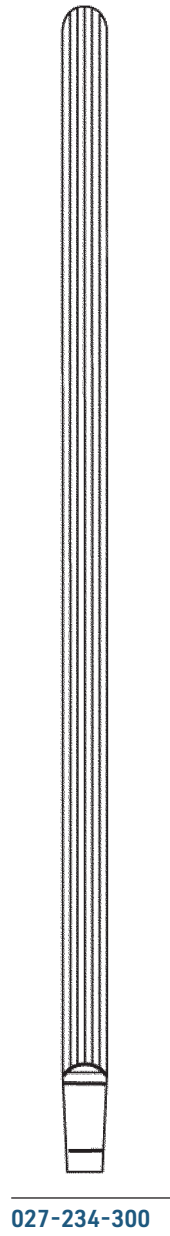
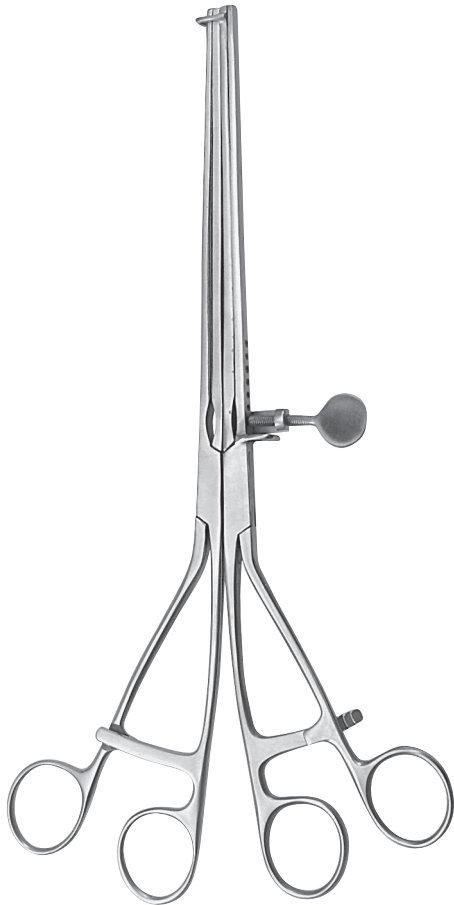

**LANE**

027-234-300 - 027-235-300

30,0 cm / 11<sup>3</sup>/<sub>4</sub>"



027

Klemmen  
Clamps  
Pinzas  
Pinze

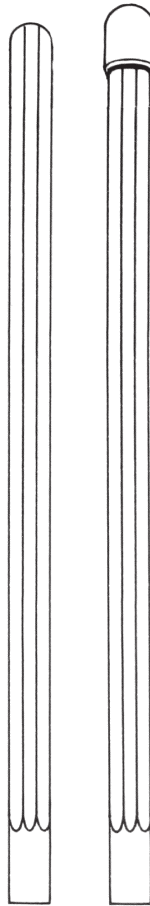

027-236-250  
027-236-300

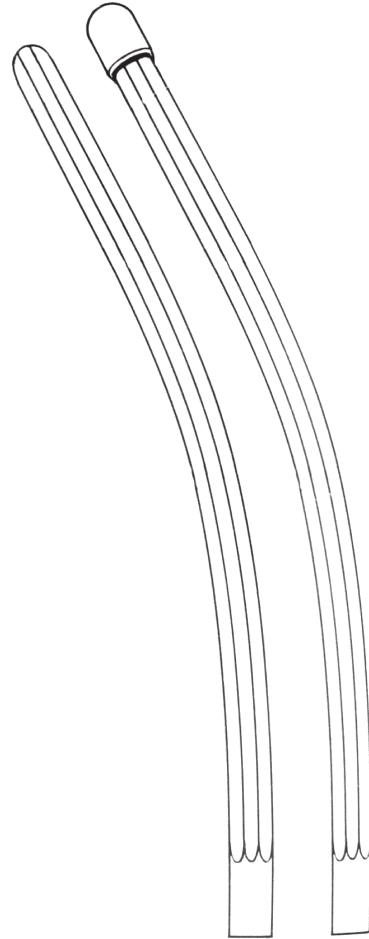

027-237-250  
027-237-300

**NUSSBAUM**

027-236-250 - 027-237-250  
027-236-300 - 027-237-300

25,0 cm / 9<sup>3</sup>/<sub>4</sub>"  
30,0 cm / 11<sup>3</sup>/<sub>4</sub>"

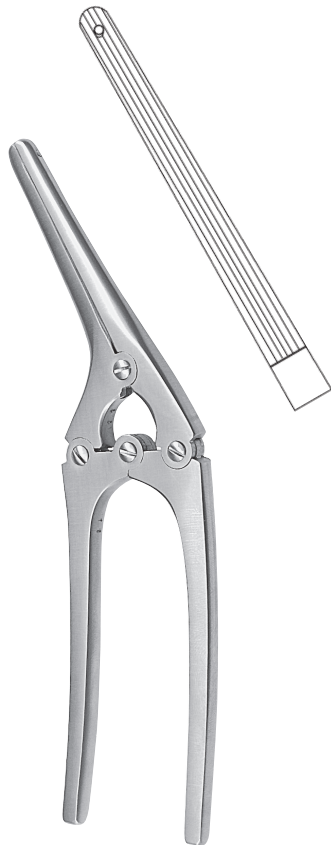

**PAYR-BABY**

**027-240-150** 15,0 cm / 6"

mit Stift  
with pin  
con espiga  
con perno

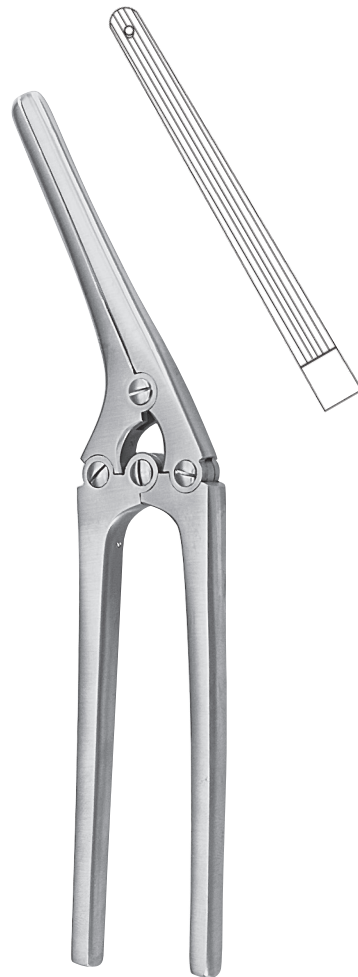

**PAYR**

**027-250-210** 21,0 cm / 8<sup>1</sup>/<sub>4</sub>"  
**027-250-290** 29,0 cm / 11<sup>1</sup>/<sub>3</sub>"  
**027-250-350** 35,0 cm / 13<sup>3</sup>/<sub>4</sub>"

mit Stift  
with pin  
con espiga  
con perno



027

Klemmen  
Clamps  
Pinzas  
Pinze

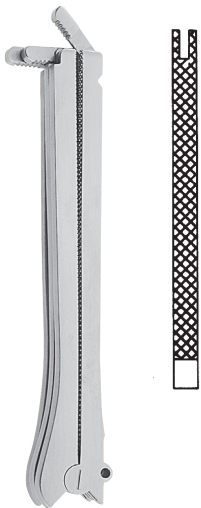

**DE MARTEL-WOLFSON**

**027-260-005** 5,0 cm / 2"  
**027-260-007** 7,0 cm / 2 1/2"  
**027-260-100** 10,0 cm / 4"



**DE MARTEL-WOLFSON**

**027-261-260** 26,0 cm / 10 1/4"



**DE MARTEL-WOLFSON**

**027-270-085** 8,5 cm / 3 1/2"



**DE MARTEL-WOLFSON**

**027-270-230** 23,0 cm / 9"

## ATRAUMA



**027-300-250** 25,0 cm / 9<sup>3</sup>/<sub>4</sub>"

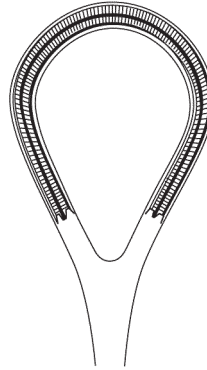

**027-300-260** 26,0 cm / 10<sup>1</sup>/<sub>4</sub>"

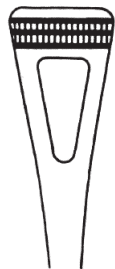

**027-304-180** 18,0 cm / 7"

schmal  
narrow  
estrecho  
stretto

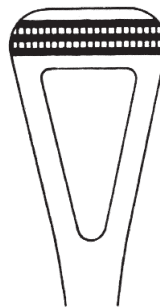

**027-304-205** 20,5 cm / 8"

mittel  
medium  
mediano  
medio

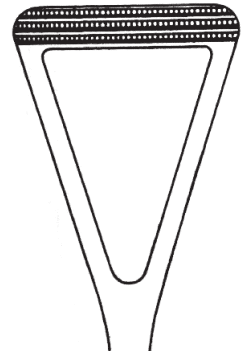

**027-304-230** 23,0 cm / 9"

breit  
wide  
ancho  
largo

## SCHEIBE



027

Darm- und Gewebefasszangen  
Intestinal and Tissue Grasping Forceps  
Pinzas intestinales y para tejidos  
Pinze da presa per intestino e tessuti

## ATRAUMA



027-310-130



027-310-160

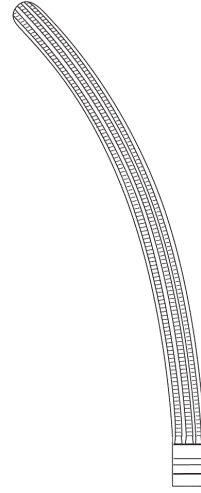

027-311-130

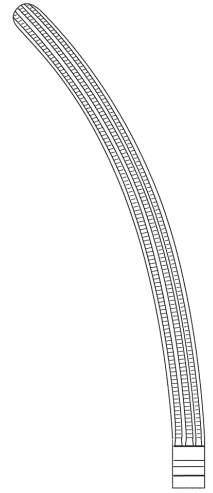

027-311-160

### BABY-DOYEN

027-310-130 - 027-311-130	13,0 cm / 5 <sup>1</sup> / <sub>8</sub> "
027-310-160 - 027-311-160	16,0 cm / 6 <sup>1</sup> / <sub>4</sub> "



027-314-180

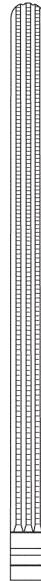

027-314-210



027-314-230

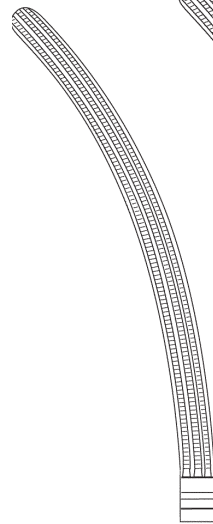

027-315-180

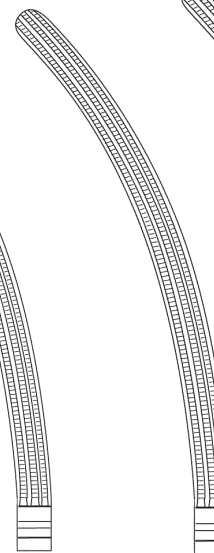

027-315-210

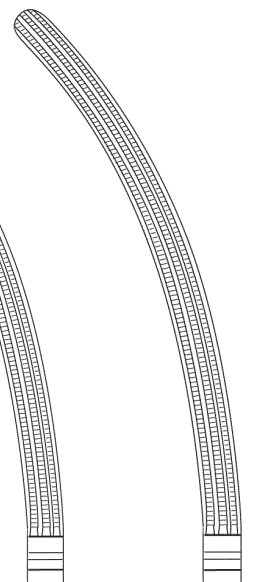

027-315-230

### DOYEN

027-314-180 - 027-315-180	18,0 cm / 7"
027-314-210 - 027-315-210	21,0 cm / 8 <sup>1</sup> / <sub>4</sub> "
027-314-230 - 027-315-230	23,0 cm / 9"

## ATRAUMA



027-320-250

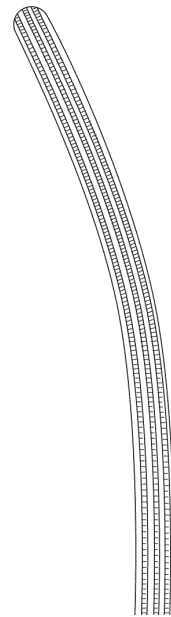

027-321-250

### MAYO-ROBSON

027-320-250 - 027-321-250

25,0 cm / 9<sup>3</sup>/<sub>4</sub>"

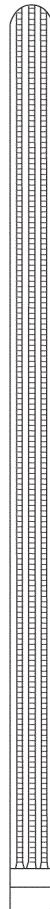

027-330-220 22,0 cm / 8<sup>3</sup>/<sub>4</sub>"  
027-330-250 25,0 cm / 9<sup>3</sup>/<sub>4</sub>"  
027-330-280 28,0 cm / 11"

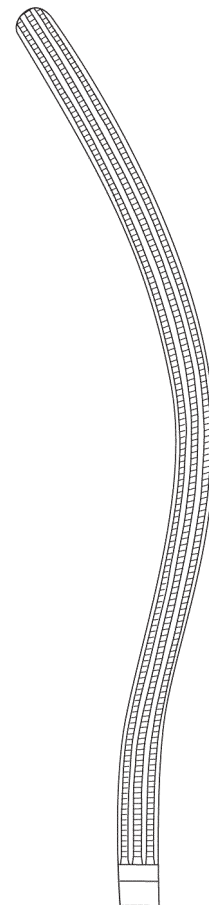

027-331-220 22,0 cm / 8<sup>3</sup>/<sub>4</sub>"  
027-331-250 25,0 cm / 9<sup>3</sup>/<sub>4</sub>"  
027-331-280 28,0 cm / 11"

### KOCHER



027

Klemmen  
Clamps  
Pinzas  
Pinze

# ATRAUMA

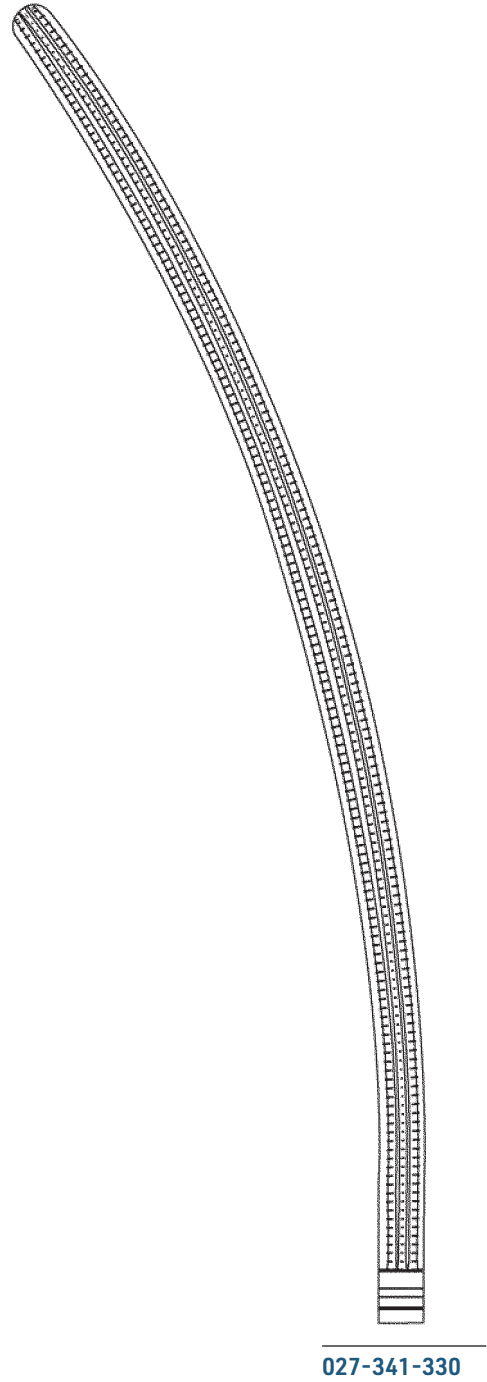
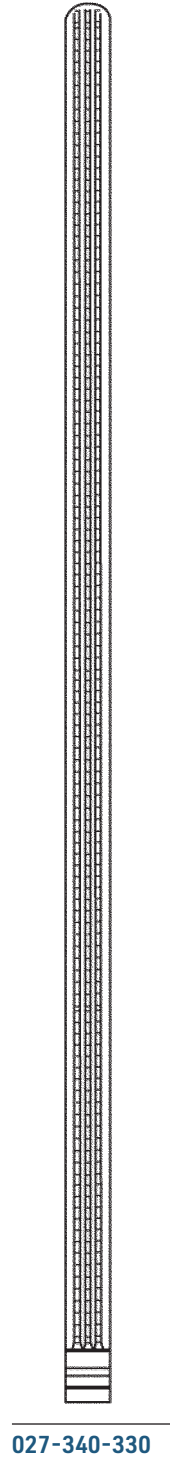

**SCUDDER**

027-340-330 - 027-341-330

33,0 cm / 13"



## ATRAUMA



**BRUNNER**

**027-345-240** 24,0 cm / 9 1/2"

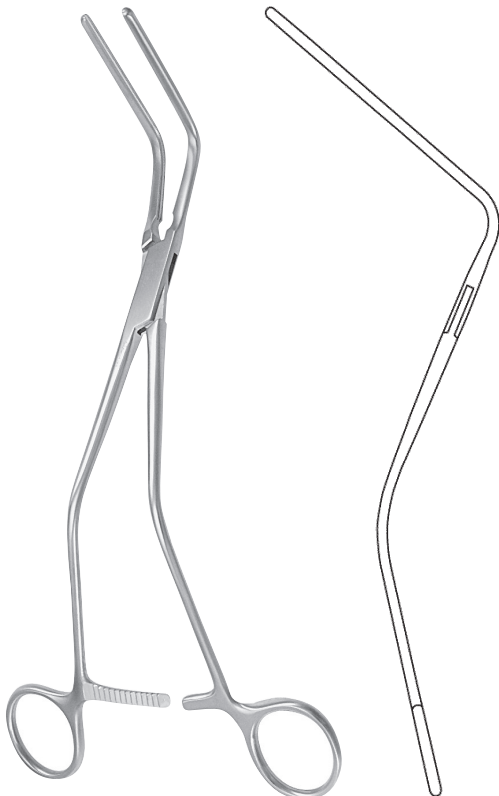
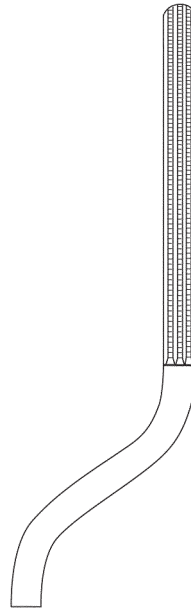

**HAYES**

**027-349-260 - 027-349-280**

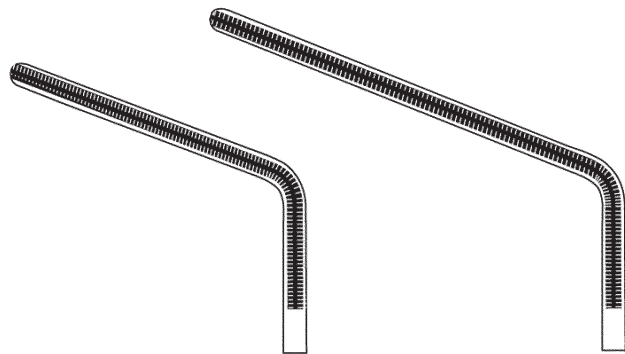

**027-349-260** 26,0 cm / 10"

**027-349-280** 28,0 cm / 11"



027

Klemmen  
Forceps  
Pinzas  
Pinze

## ATRAUMA

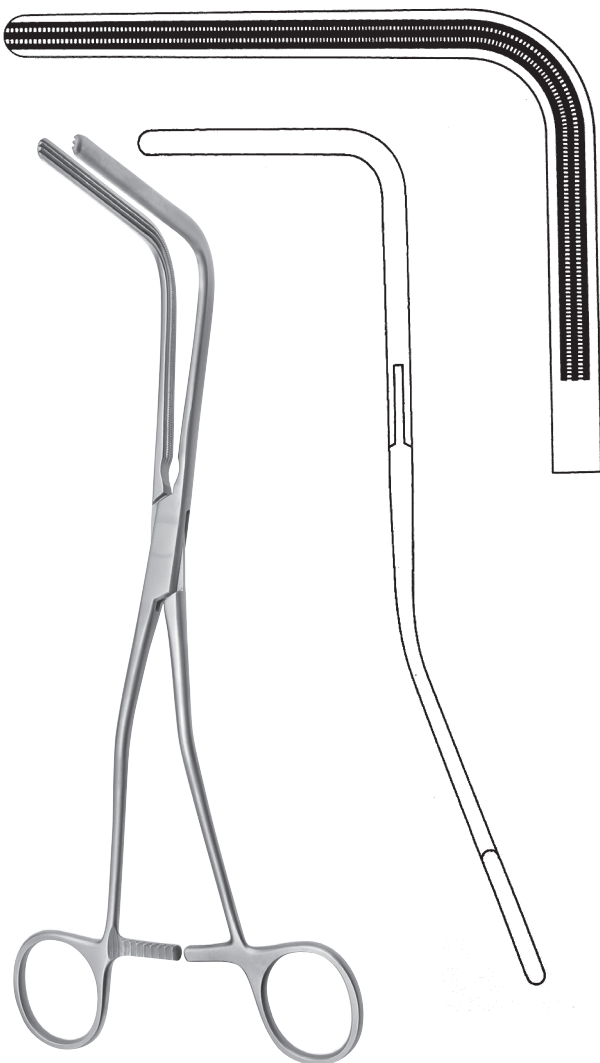

**VEIDENHEIMER**

**027-351-250** 25,0 cm / 9<sup>3</sup>/<sub>4</sub>"



**FEHLAND**

**027-353-240** 24,0 cm / 9<sup>1</sup>/<sub>2</sub>"

## ATRAUMA

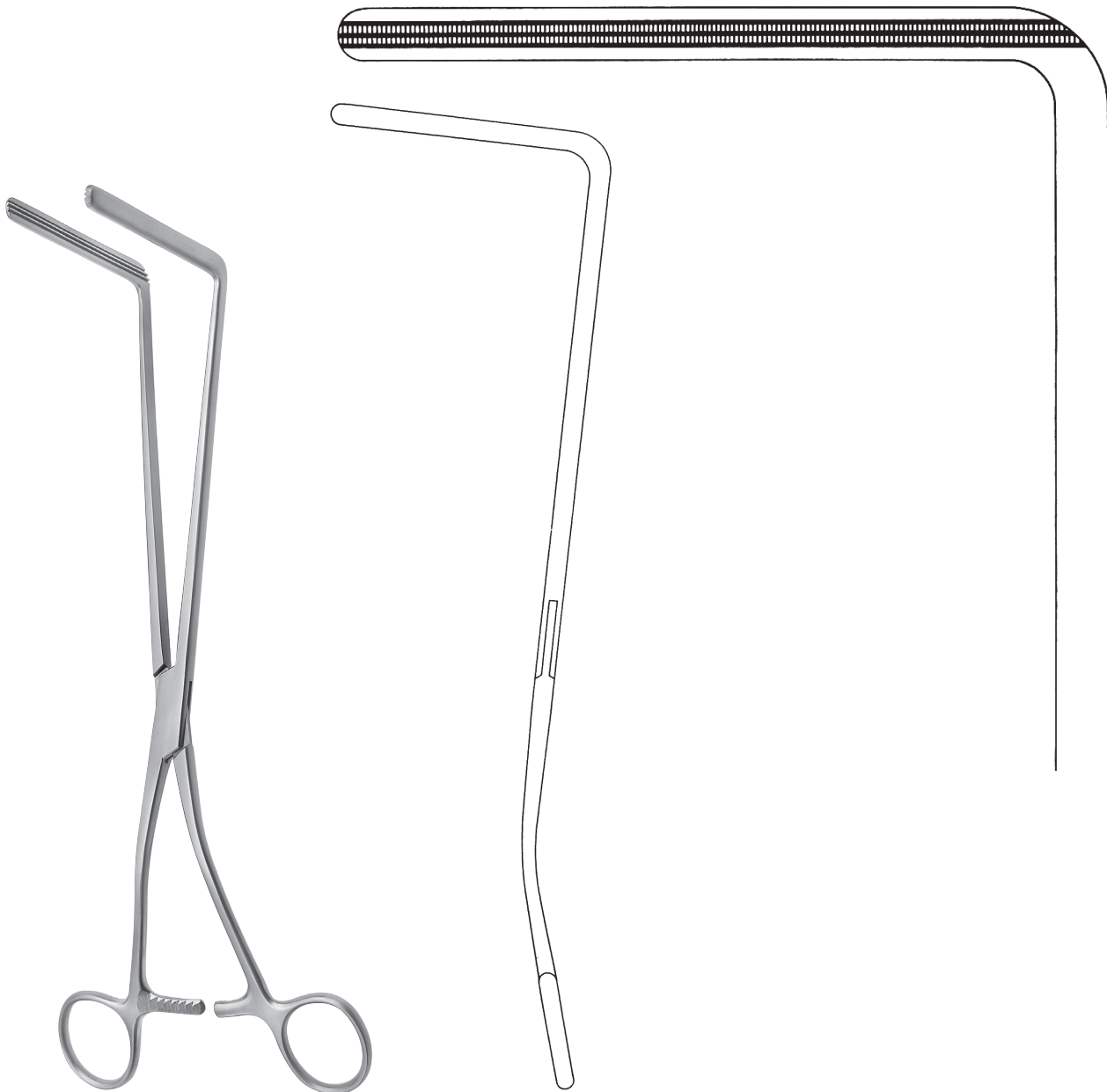

**RESANO**

**027-355-300** 30,0 cm / 11"



027

Mastdarm-Rektum-Spekula  
Rectal Specula  
Espéculos para el recto  
Speculi rettali



**CZERNY**

**027-400-220** 22,0 cm / 9 1/2"



**SIMS**

**027-402-150** 15,0 cm / 6"



**BODENHAMMER**

**027-404-150** 15,0 cm / 6"



**PRATT**

**027-408-200** 20,0 cm / 8"



70 x 22 mm

**BARR**

**027-410-170** 17,0 cm / 6<sup>3</sup>/<sub>4</sub>"



027

Mastdarm-Rektum-Spekula  
Rectal Specula  
Espéculos para el recto  
Speculi rettali



**MATHIEU**

**027-414-210** 21,0 cm / 8 1/4"



**SMITH BUIE**

**027-426-150** 15,0 cm / 6"



**SCHULZE-BERGMANN**

**027-420-060 - 027-420-125**

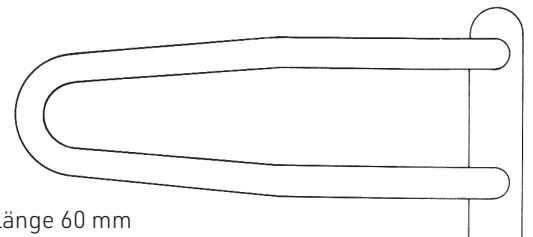

Valvenlänge 60 mm  
Length of Blades 60 mm  
Largo de valvas 60 mm  
Lunghezza di valvi 60 mm

**027-420-060**

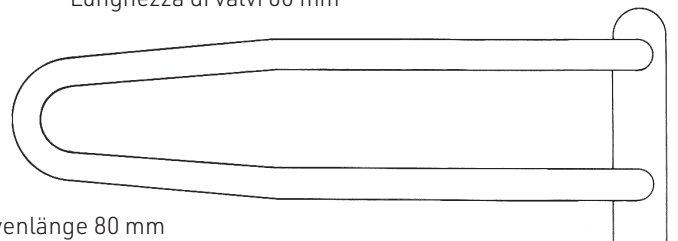

Valvenlänge 80 mm  
Length of Blades 80 mm  
Largo de valvas 80 mm  
Lunghezza di valvi 80 mm

**027-420-080**

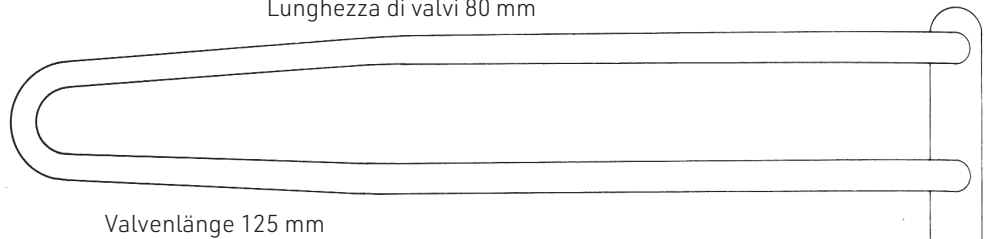

Valvenlänge 125 mm  
Length of Blades 125 mm  
Largo de valvas 125 mm  
Lunghezza di valvi 125 mm

**027-420-125**

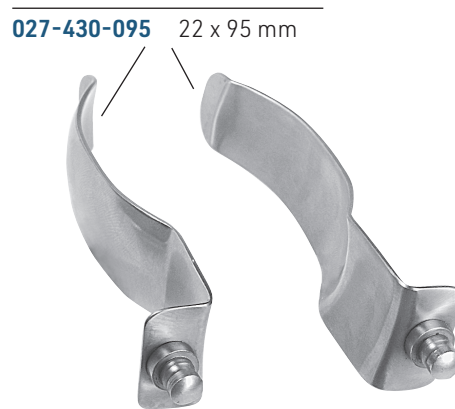
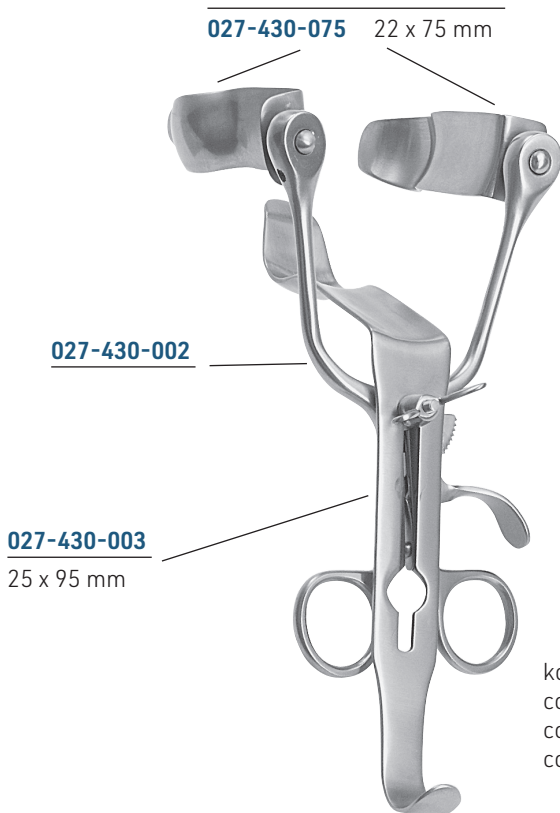

**ALAN PARKS**

**027-430-001** 13,5 cm / 5<sup>3</sup>/<sub>8</sub>"

komplett mit Kaltlichtträger  
 complete with cold light carrier  
 completo con portador para luz fria  
 completo con supporto per luce fredda

komplett ohne Kaltlichtträger  
 complete without cold light carrier  
 completo sin portador para luz fria  
 completo senza supporto per luce fredda

**ALAN PARKS**

**027-430-000** 13,5 cm / 5<sup>1</sup>/<sub>4</sub>"



ohne Kaltlichtträger  
 without cold light carrier  
 sin portador para luz fria  
 senza supporto per luce fredda

**IVES FANSLER**

**027-440-001** Ø 22 mm



mit Kaltlichtträger  
 with cold light carrier  
 con portador para luz fria  
 con supporto per luce fredda

**IVES FANSLER**

**027-440-002** Ø 22 mm

**027-440-003**

Kunststoffobturator allein  
 Obturator of plastic only  
 Obturador de plastico suelto  
 Otturatore di plastica solo

**HIRSCHMANN**

**027-444-001** Ø 16 x 65 mm

**027-444-002** Ø 19 x 65 mm

**027-444-003** Ø 22 x 70 mm



027

Analpreizer, Sphinkteroskope, Anuskope  
Rectal Retractor, Sphincteroscopes, Anoscopes  
Separadores para el recto, Esfinteroscopios, Anoscopios  
Dilatatori per l'ano e il retto, Sfinteroscopi, Anoscopi



**KELLY**

**027-452-021** Ø 21 x 50 mm  
**027-452-027** Ø 27 x 50 mm



**FANSLER**

**027-454-025** Ø 25 x 65 mm  
**027-454-029** Ø 29 x 65 mm  
**027-454-038** Ø 38 x 70 mm



**PRATT**

21,0 cm / 8 1/4"



**027-460-001**



**027-460-002**



**027-460-003**





**YEOMAN**

**027-470-280** 28,0 cm / 11"  
**027-470-350** 35,0 cm / 13<sup>3</sup>/<sub>4</sub>"  
**027-470-420** 42,0 cm / 16<sup>1</sup>/<sub>2</sub>"

**027-472-280** 28,0 cm / 11"  
**027-472-350** 35,0 cm / 13<sup>3</sup>/<sub>4</sub>"  
**027-472-420** 42,0 cm / 16<sup>1</sup>/<sub>2</sub>"

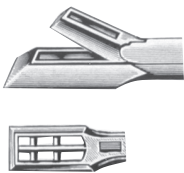

**027-476-280** 28,0 cm / 11"  
**027-476-350** 35,0 cm / 13<sup>3</sup>/<sub>4</sub>"  
**027-476-420** 42,0 cm / 16<sup>1</sup>/<sub>2</sub>"

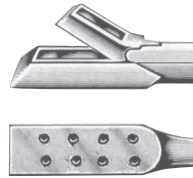

**027-478-280** 28,0 cm / 11"  
**027-478-350** 35,0 cm / 13<sup>3</sup>/<sub>4</sub>"  
**027-478-420** 42,0 cm / 16<sup>1</sup>/<sub>2</sub>"

Haemorrhoiden-Ligator mit Ladekonus  
 Haemorrhoidal ligator with loading attachment  
 Ligador para hemorroides con cono de carga  
 Legatori emorroidali con carica a cono



**RUDD**  
**027-486-000**

**027-486-012** Ø 12,0 mm



**MC GIVNEY**  
**027-488-000**

**027-486-012** Ø 12,0 mm



**027-488-100**  
 Gumminge 100  
 Stück  
 Rubber rings 100 pieces  
 Anillos de goma 100 unidades  
 Anelli di gomma 100 pezzi



027

Polypenfasszangen  
Polypus Grasping Forceps  
Pinzas para coger pólipos  
Pinze per afferrare polipi

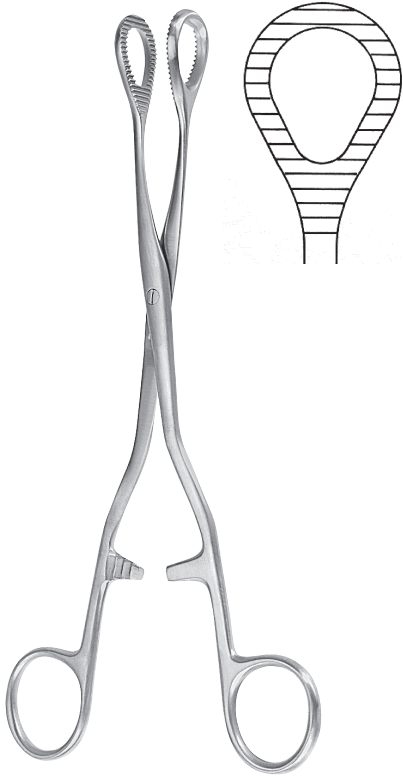

**HEYWOOD-SMITH**

**027-490-210** 21,0 cm / 8<sup>1</sup>/<sub>4</sub>"  
**027-490-250** 25,0 cm / 9<sup>3</sup>/<sub>4</sub>"

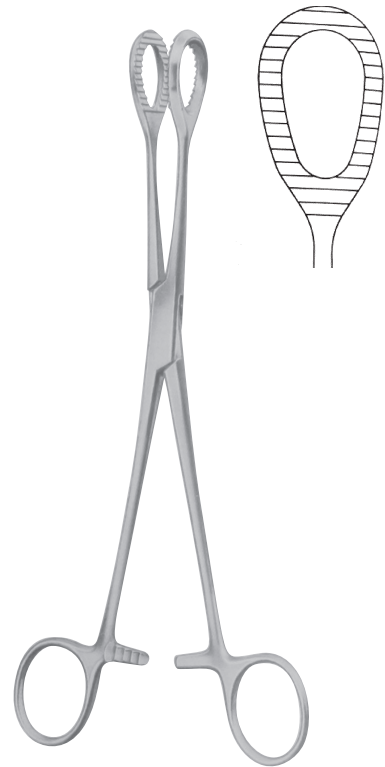

**HEYWOOD-SMITH**

**027-492-210** 21,0 cm / 8<sup>1</sup>/<sub>4</sub>"  
**027-492-250** 25,0 cm / 9<sup>3</sup>/<sub>4</sub>"

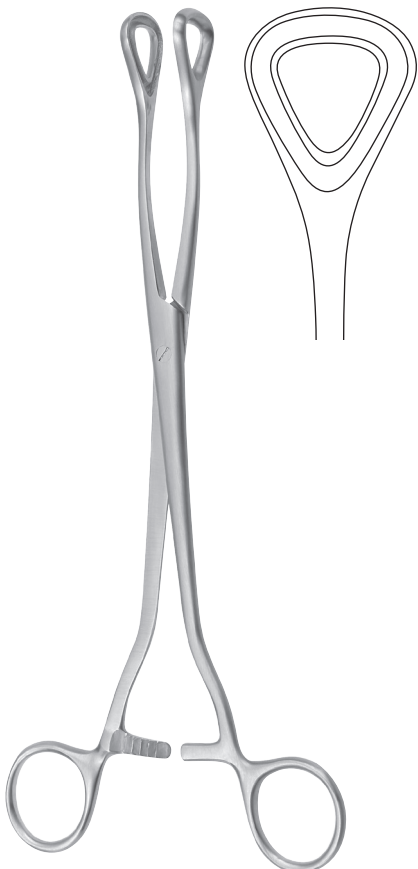

**LUER**

**027-494-245** 24,5 cm / 9<sup>2</sup>/<sub>3</sub>"



**MC GIVNEY**

**027-495-190** 19,0 cm / 7<sup>1</sup>/<sub>2</sub>"



**MC GIVNEY**

**027-497-190** 19,0 cm / 7<sup>1</sup>/<sub>2</sub>"

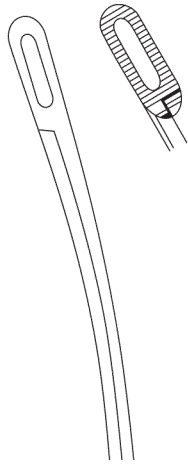

**027-531-001** 23,0 cm / 9"

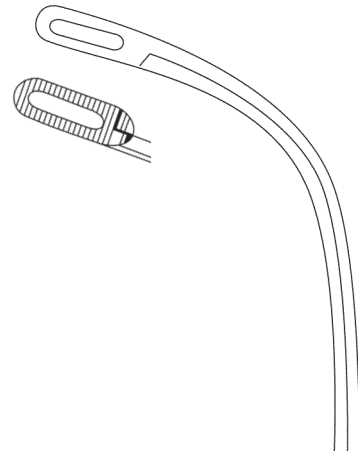

**027-531-002** 22,0 cm / 8<sup>5</sup>/<sub>8</sub>"



**RANDALL**

**027-531-001 - 027-531-004**

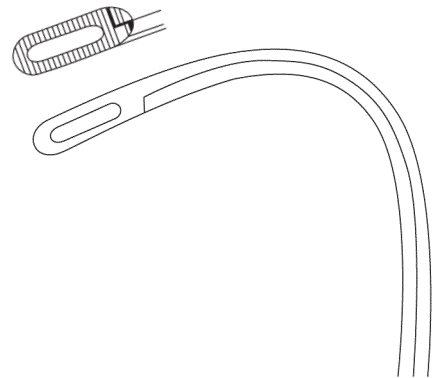

**027-531-003** 19,0 cm / 7<sup>1</sup>/<sub>2</sub>"

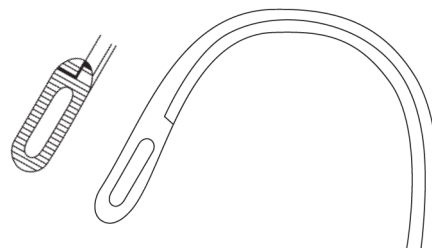

**027-531-004** 19,0 cm / 7<sup>1</sup>/<sub>2</sub>"



027

Nierensteinzangen, Gallensteinzangen  
Kidney Stone Forceps, Gall Stone Forceps  
Pinzas para los cálculos renales, Pinzas para los cálculos biliares  
Pinze per calcoli renali, Pinze per calcoli biliari

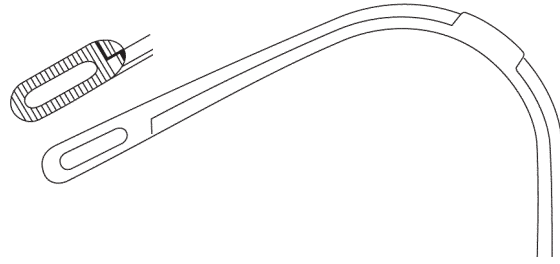

027-531-005

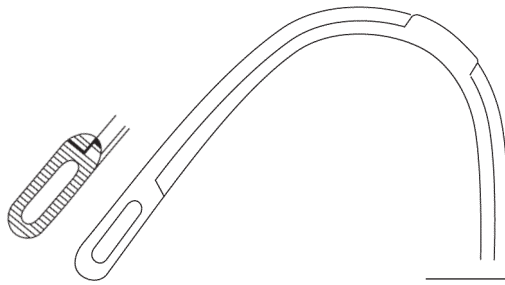

027-531-006

**RANDALL**

027-531-005 - 027-531-006

19,0 cm / 7 1/2"

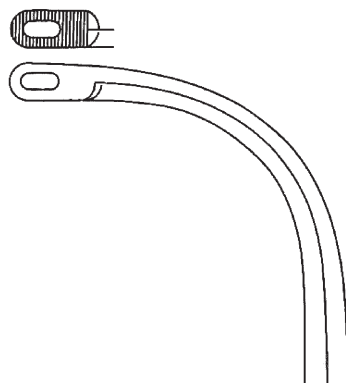

027-535-160 16,0 cm / 6 1/4"

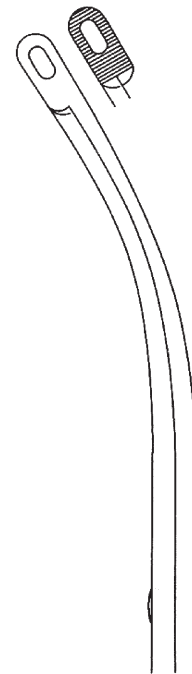

027-535-170 17,0 cm / 6 3/4"

**HEIMING**

027-535-160 - 027-535-170

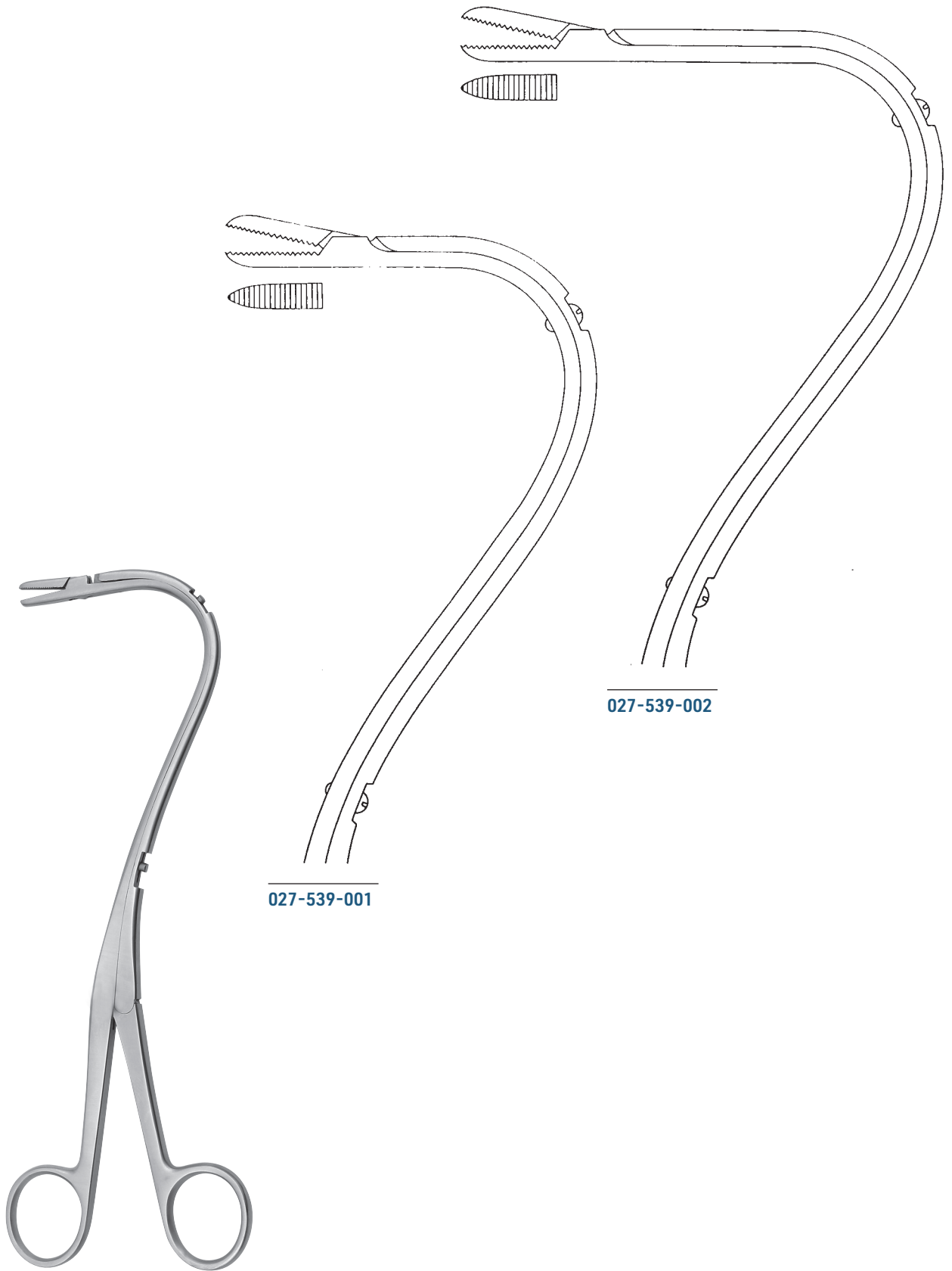

ELSÄSSER

027-539-001 - 027-539-002

21,0 cm / 8<sup>1</sup>/<sub>4</sub>"



027

Gallengang Dilatoren  
 Common Bile Duct Dilators  
 Diladores para el conducto biliar  
 Dilatori per coledoco



027-540-001 Ø 1,0 mm



027-540-002 Ø 2,0 mm



027-540-003 Ø 3,0 mm



027-540-004 Ø 4,0 mm



027-540-005 Ø 5,0 mm



027-540-006 Ø 6,0 mm



biegsamer Schaft  
 malleable shaft  
 vastago maleabile  
 asta malleabile



027-540-007 Ø 7,0 mm

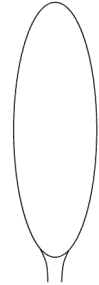

027-540-011 Ø 11,0 mm



027-540-008 Ø 8,0 mm

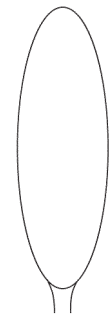

027-540-012 Ø 12,0 mm



027-540-009 Ø 9,0 mm

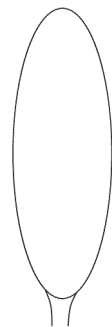

027-540-010 Ø 10,0 mm

027-540-013 Ø 13,0 mm



027-540-000

Satz à 9 Stück ø 3,0 - 11,0 mm  
 set of 9 pieces ø 3,0 - 11,0 mm  
 juego de 9 piezas ø 3,0 - 11,0 mm  
 set di 9 pezzi ø 3,0 - 11,0 mm

BAKES

027-540-001 - 027-540-013 30,0 cm / 11<sup>3</sup>/<sub>4</sub>"

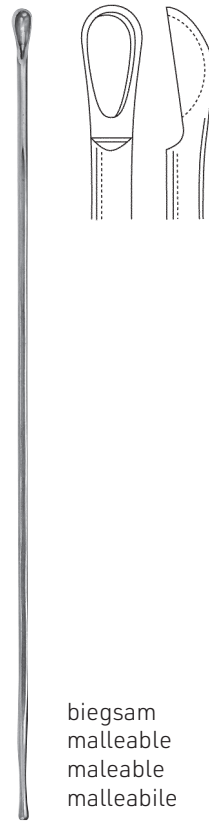

biegsam  
 malleable  
 maleable  
 malleabile

**MOYNIHAN**

**027-544-340** 34,0 cm / 13<sup>3</sup>/<sub>4</sub>"



**027-546-013** 13 Charr.



**027-546-018** 18 Charr.



**027-546-021** 21 Charr.

federnd  
 flexible  
 flexible  
 flessibile

**DESJARDINS**

**027-546-013 - 027-546-021** 28,0 cm / 11"



biegsam  
 malleable  
 maleable  
 malleabile

**MAYO**

**027-548-320** 32,0 cm / 12<sup>1</sup>/<sub>2</sub>"



027

Gallensteinzangen  
 Gall Stone Forceps  
 Pinzas para los cálculos biliares  
 Pinze per calcoli biliari



**CZERNY**

**027-551-245** 24,5 cm / 9<sup>5</sup>/<sub>8</sub>"



**TURNER-WARWICK**

**027-553-180** 18,0 cm / 7"  
**027-553-190** 19,0 cm / 7<sup>1</sup>/<sub>2</sub>"

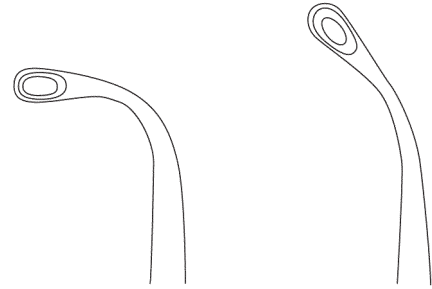

**027-553-180**

**027-553-190**



**BLAKE**

**027-556-200 - 027-557-200** 20,0 cm / 8"

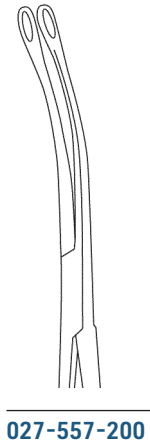

**027-557-200**



**MAYO-BLAKE**

**027-560-200 - 027-561-200** 20,0 cm / 8"



**027-561-200**





**MIXTER**  
**027-563-220** 22,0 cm / 8<sup>3</sup>/<sub>4</sub>"



**DESJARDINS**  
**027-565-001 - 027-565-002** 23,0 cm / 9"



**STILLE**  
**027-567-245** 24,5 cm / 9<sup>2</sup>/<sub>3</sub>"

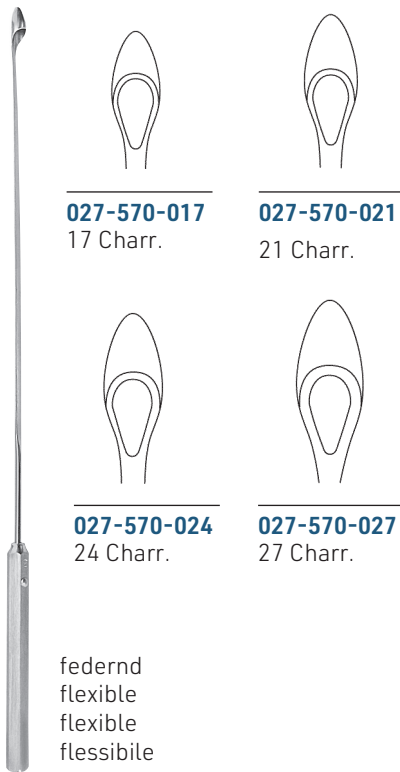

**027-570-017**  
 17 Charr.

**027-570-021**  
 21 Charr.

**027-570-024**  
 24 Charr.

**027-570-027**  
 27 Charr.

federnd  
 flexible  
 flexible  
 flessibile

**DESJARDINS**  
**027-570-017 - 027-570-027** 30,0 cm / 11<sup>3</sup>/<sub>4</sub>"

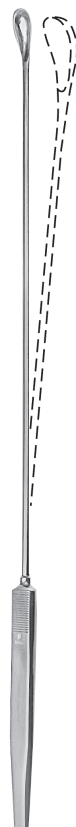
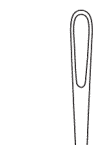

Fig. 000

Fig. 00

Fig. 0

Fig. 1



**027-580-001**  
 ø 2,5 mm

**027-580-002**  
 ø 3,2 mm

**027-580-003**  
 ø 4,2 mm

**027-580-004**  
 ø 5,5 mm

Fig. 2

Fig. 3

Fig. 4

Fig. 5



**027-580-005**  
 ø 6,7 mm

**027-580-006**  
 ø 8,0 mm

**027-580-007**  
 ø 11,0 mm

**027-580-008**  
 ø 15,0 mm

**LUER-KÖRTE**  
**027-580-001 - 027-580-008** 32,0 cm / 12<sup>1</sup>/<sub>2</sub>"

biegsamer Schaft  
 malleable shaft  
 vastago maleabile  
 asta malleabile



027

Gallensteinlöffel  
Gall Stone Scoops  
Cucharillas para los cálculos biliares  
Cucchiai per calcoli biliari



Gallenblasenlöffel  
Gall bladder scoope  
Cucharilla para la vesicula biliar  
Cucchiaio pre colecisti

**MOORE**

**027-582-300** 30,0 cm / 12"



**MAYO**

**027-584-280** 28,0 cm / 11"



**FERGUSSON**

**027-586-215** 21,5 cm / 8½"



**YOUNG**

**027-701-210** 21,0 cm / 8<sup>1</sup>/<sub>4</sub>"



**YOUNG**

**027-703-220** 22,0 cm / 8<sup>5</sup>/<sub>8</sub>"



**YOUNG**

**027-705-210** 21,0 cm / 8<sup>1</sup>/<sub>4</sub>"

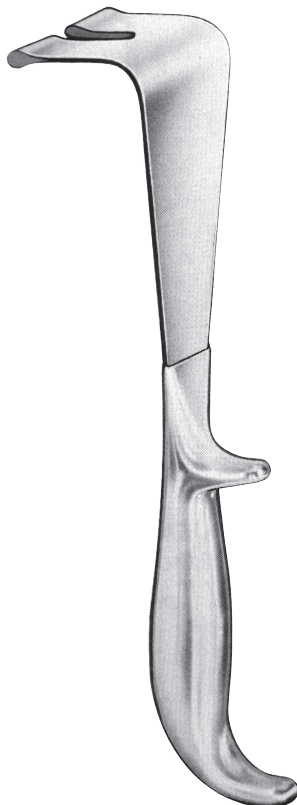

**YOUNG**

**027-707-220** 22,0 cm / 8<sup>5</sup>/<sub>8</sub>"



**YOUNG**

**027-710-200** 20,0 cm / 8"



**ATRAUMA**



**MILLIN**

**027-711-240** 24,0 cm / 9 1/2"



**ATRAUMA**



**MILLIN**

**027-713-240** 24,0 cm / 9 1/2"

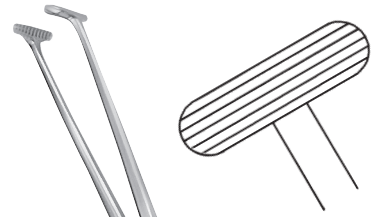

**ATRAUMA**



**MILLIN**

**027-715-240** 24,0 cm / 9 1/2"



**MILLIN**

**027-717-230** 23,0 cm / 9"

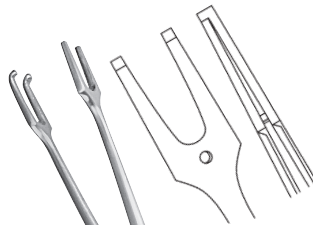

**MILLIN**

**027-719-240** 24,0 cm / 9 1/2"

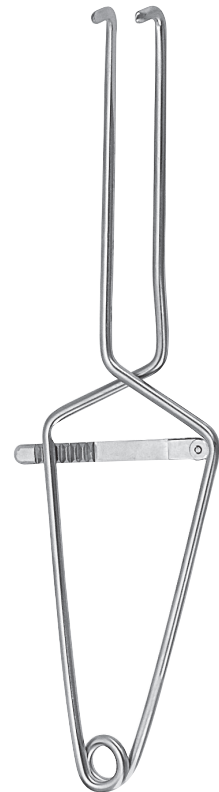

**MILLIN**

**027-725-285** 28,5 cm / 11 1/4"

**JUDD-MASSON**

**027-740-000**

ohne Mittelblatt  
without central blade  
sin valva central  
senza valva centrale

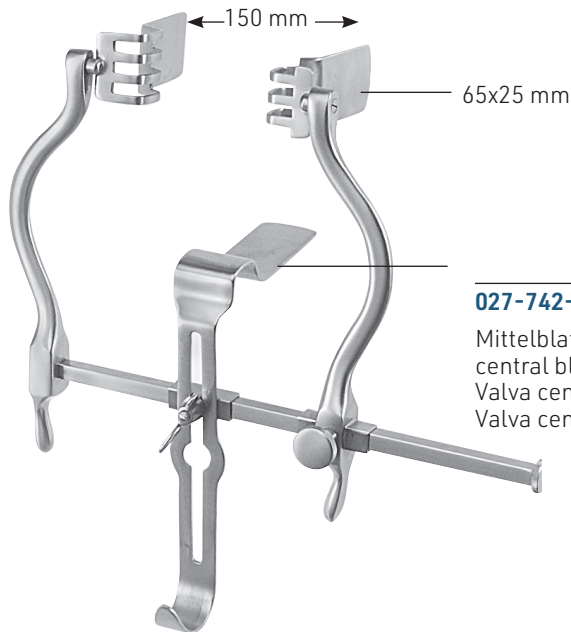

**027-742-001**

75x25 mm

Mittelblatt  
central blade  
Valva central  
Valva centrale

**JUDD-MASSON**

**027-742-000**

mit Mittelblatt  
with central blade  
con valva central  
con valva centrale

**JUDD-MASSON**

**027-750-003**

Seitenvalven  
latral blades  
Valvas laterales  
Valva laterale

**027-750-002**

Seitenvalven  
latral blades  
Valvas laterales  
Valva laterale



**027-750-001**

Rahmen allein  
Frame only  
Cuadro suelto  
telaio solo

**027-750-004**

Mittelblatt  
central blade  
Valva central  
Valva centrale



**027-754-001**

Kaltlichtaufsatz  
cold light carrier  
portador para luz fria  
supporto per luce fredda

**MILLIN**

**027-750-000**

**MILLIN**

**027-754-000**



027

Prostatahaken, Blasenspatel  
Prostatic Retractors, Bladder Spatulas  
Separadores para la prostata, Espátulas vesicales  
Retrattori prostatici, Spatole vescicali

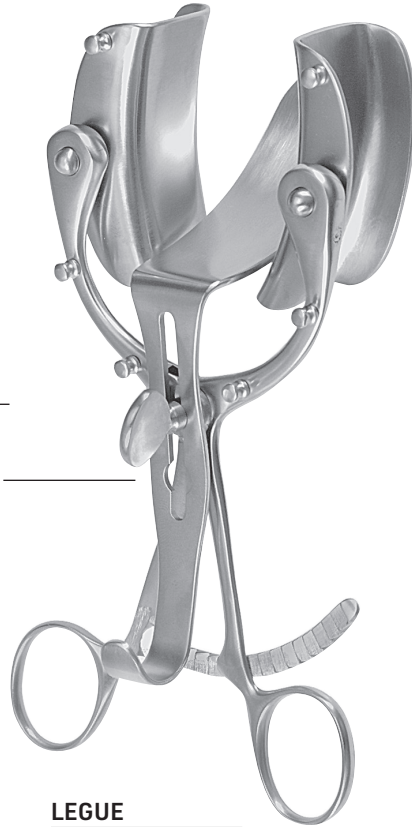

**027-760-002** 70 x 32 mm  
Mittelvalve  
center blade  
Valva central  
Valva centrale

**027-760-001** 28 x 60 mm  
Seitenvalven  
lateral blades  
Valvas laterales  
Valva laterale

**LEGUE**  
**027-760-000**



35 mm

**LEGUEU**  
**027-765-270** 30,0 cm / 11<sup>1</sup>/<sub>4</sub>"



67 mm

**KOCHER**  
**027-767-270** 27,0 cm / 10<sup>3</sup>/<sub>4</sub>"

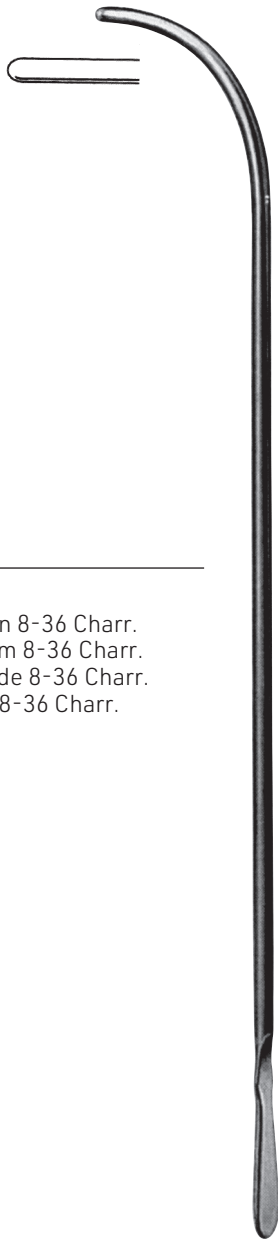

**027-781-000**

Satz komplett von 8-36 Charr.  
Set complete from 8-36 Charr.  
Juego completo de 8-36 Charr.  
Set completo da 8-36 Charr.



**VAN BUREN**

<b>027-781-008</b>	Ø 2 <sup>2</sup> / <sub>3</sub> mm	Char. 8
<b>027-781-010</b>	Ø 3 <sup>1</sup> / <sub>3</sub> mm	Char. 10
<b>027-781-012</b>	Ø 4 mm	Char. 12
<b>027-781-014</b>	Ø 4 <sup>2</sup> / <sub>3</sub> mm	Char. 14
<b>027-781-016</b>	Ø 5 <sup>1</sup> / <sub>3</sub> mm	Char. 16
<b>027-781-018</b>	Ø 6 mm	Char. 18
<b>027-781-020</b>	Ø 6 <sup>2</sup> / <sub>3</sub> mm	Char. 20
<b>027-781-022</b>	Ø 7 <sup>1</sup> / <sub>3</sub> mm	Char. 22
<b>027-781-024</b>	Ø 8 mm	Char. 24
<b>027-781-026</b>	Ø 8 <sup>2</sup> / <sub>3</sub> mm	Char. 26
<b>027-781-028</b>	Ø 9 <sup>1</sup> / <sub>3</sub> mm	Char. 28
<b>027-781-030</b>	Ø 10 mm	Char. 30
<b>027-781-032</b>	Ø 10 <sup>2</sup> / <sub>3</sub> mm	Char. 32
<b>027-781-034</b>	Ø 11 <sup>1</sup> / <sub>3</sub> mm	Char. 34
<b>027-781-036</b>	Ø 12 mm	Char. 36

**GUYON**

<b>027-791-012</b>	Ø 4 mm	Char. 12
<b>027-791-013</b>	Ø 4 <sup>1</sup> / <sub>3</sub> mm	Char. 13
<b>027-791-014</b>	Ø 4 <sup>2</sup> / <sub>3</sub> mm	Char. 14
<b>027-791-015</b>	Ø 5 mm	Char. 15
<b>027-791-016</b>	Ø 5 <sup>1</sup> / <sub>3</sub> mm	Char. 16
<b>027-791-017</b>	Ø 5 <sup>2</sup> / <sub>3</sub> mm	Char. 17
<b>027-791-018</b>	Ø 6 mm	Char. 18
<b>027-791-019</b>	Ø 6 <sup>1</sup> / <sub>3</sub> mm	Char. 19
<b>027-791-020</b>	Ø 6 <sup>2</sup> / <sub>3</sub> mm	Char. 20
<b>027-791-021</b>	Ø 7 mm	Char. 21
<b>027-791-022</b>	Ø 7 <sup>1</sup> / <sub>3</sub> mm	Char. 22
<b>027-791-023</b>	Ø 7 <sup>2</sup> / <sub>3</sub> mm	Char. 23
<b>027-791-024</b>	Ø 8 mm	Char. 24
<b>027-791-025</b>	Ø 8 <sup>1</sup> / <sub>3</sub> mm	Char. 25
<b>027-791-026</b>	Ø 8 <sup>2</sup> / <sub>3</sub> mm	Char. 26
<b>027-791-027</b>	Ø 9 mm	Char. 27
<b>027-791-028</b>	Ø 9 <sup>1</sup> / <sub>3</sub> mm	Char. 28
<b>027-791-029</b>	Ø 9 <sup>2</sup> / <sub>3</sub> mm	Char. 29
<b>027-791-030</b>	Ø 10 mm	Char. 30



027

Metallkatheter  
Metal Catheters  
Sondas metalicas  
Cateteri metalliche



für Männer  
for male  
para hombres  
per uomini

27,0 cm / 10<sup>3</sup>/<sub>4</sub>"

<b>027-801-008</b>	Char. 8	ø 2 <sup>2</sup> / <sub>3</sub> mm
<b>027-801-010</b>	Char. 10	ø 3 <sup>1</sup> / <sub>3</sub> mm
<b>027-801-012</b>	Char. 12	ø 4 mm
<b>027-801-014</b>	Char. 14	ø 4 <sup>2</sup> / <sub>3</sub> mm
<b>027-801-016</b>	Char. 16	ø 5 <sup>1</sup> / <sub>3</sub> mm
<b>027-801-018</b>	Char. 18	ø 6 mm
<b>027-801-020</b>	Char. 20	ø 6 <sup>2</sup> / <sub>3</sub> mm
<b>027-801-022</b>	Char. 22	ø 7 <sup>1</sup> / <sub>3</sub> mm
<b>027-801-024</b>	Char. 24	ø 8 mm



für Frauen  
for female  
para mujeres  
per donne

15,0 cm / 6"

<b>027-811-006</b>	Char. 6	ø 2 mm
<b>027-811-007</b>	Char. 7	ø 2 <sup>1</sup> / <sub>3</sub> mm
<b>027-811-008</b>	Char. 8	ø 2 <sup>2</sup> / <sub>3</sub> mm
<b>027-811-009</b>	Char. 9	ø 3 mm
<b>027-811-010</b>	Char. 10	ø 3 <sup>1</sup> / <sub>3</sub> mm
<b>027-811-011</b>	Char. 11	ø 3 <sup>2</sup> / <sub>3</sub> mm
<b>027-811-012</b>	Char. 12	ø 4 mm
<b>027-811-013</b>	Char. 13	ø 4 <sup>1</sup> / <sub>3</sub> mm
<b>027-811-014</b>	Char. 14	ø 4 <sup>2</sup> / <sub>3</sub> mm
<b>027-811-015</b>	Char. 15	ø 5 mm
<b>027-811-016</b>	Char. 16	ø 5 <sup>1</sup> / <sub>3</sub> mm
<b>027-811-018</b>	Char. 18	ø 6 mm
<b>027-811-020</b>	Char. 20	ø 6 <sup>2</sup> / <sub>3</sub> mm
<b>027-811-022</b>	Char. 22	ø 7 <sup>1</sup> / <sub>3</sub> mm
<b>027-811-024</b>	Char. 24	ø 8 mm





**COMCO**

- 027-830-008** ø 8,0 mm
- 027-830-011** ø 11,0 mm
- 027-830-013** ø 13,0 mm
- 027-830-016** ø 16,0 mm
- 027-830-021** ø 21,0 mm
- 027-830-026** ø 26,0 mm
- 027-830-032** ø 32,0 mm

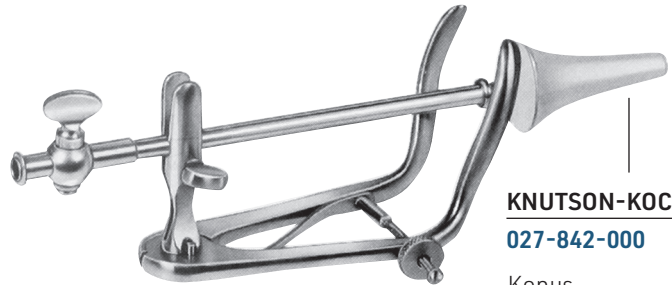

**KNUTSON-KOCH**  
**027-842-000**

- Konus
- Cone
- Cono
- Cono

**KNUTSON**

**027-840-000**



**MOGEN**

**027-846-075** 7,5 cm / 3"



**GUYON**

**027-850-390** 39,0 cm / 16"



**GUYON**

**027-851-350** 35,0 cm / 13<sup>3</sup>/<sub>4</sub>"



027

Klemmen, Fremdkörperzange  
Clamp, Foreign Body Forceps  
Compresor urétral, Pinzas  
Serrapene, Pinze



**STRAUSS**

**027-860-110** 11,0 cm / 4<sup>1</sup>/<sub>3</sub>"



**STOCKMANN**

**027-862-080** 8,0 cm / 3<sup>1</sup>/<sub>4</sub>"



**MATHIEU**

**027-870-200** 20,0 cm / 8"  
**027-870-280** 28,0 cm / 11"