



019

Naht  
Suture  
Sutura  
Sutura



019

Chirurgische Nadeln  
Surgical Needles  
Agujas quirúrgicas  
Aghi chirurgici

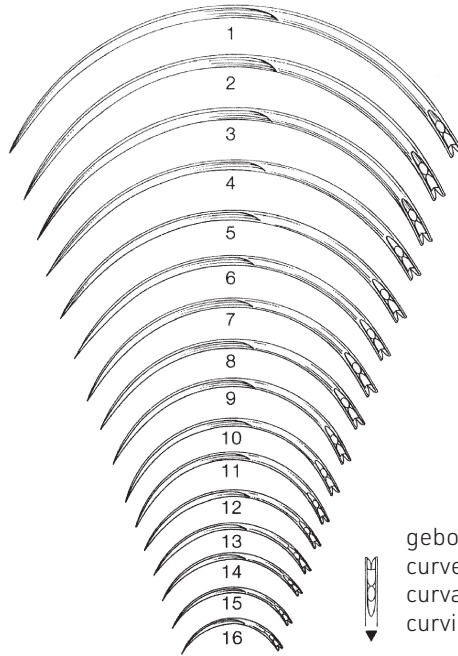

gebogen 3/8 Kreis  
curved 3/8 circle  
curvas 3/8 circulo  
curvi 3/8 circolo

\*in Packungen zu 12 Stück  
\*in packages of 12 pieces  
\*en paquets de 12 piezas  
\*in confezione da 12 pezzi

**B**

019-001-001	Fig. 1
019-001-002	Fig. 2
019-001-003	Fig. 3
019-001-004	Fig. 4
019-001-005	Fig. 5
019-001-006	Fig. 6
019-001-007	Fig. 7
019-001-008	Fig. 8
019-001-009	Fig. 9
019-001-010	Fig. 10
019-001-011	Fig. 11
019-001-012	Fig. 12
019-001-013	Fig. 13
019-001-014	Fig. 14
019-001-015	Fig. 15
019-001-016	Fig. 16

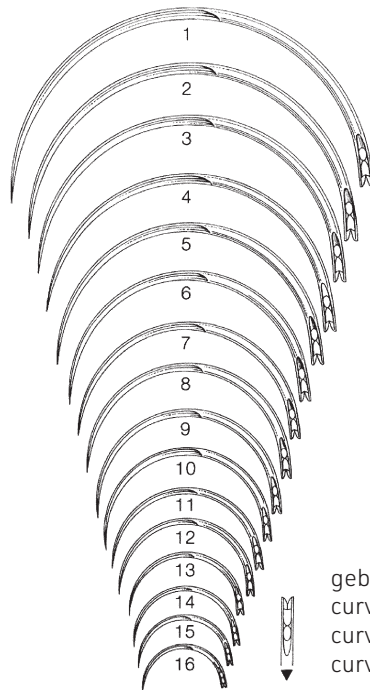

gebogen 1/2 Kreis  
curved 1/2 circle  
curvas 1/2 circulo  
curvi 1/2 circolo

\*in Packungen zu 12 Stück  
\*in packages of 12 pieces  
\*en paquets de 12 piezas  
\*in confezione da 12 pezzi

**G**

019-003-001	Fig. 1
019-003-002	Fig. 2
019-003-003	Fig. 3
019-003-004	Fig. 4
019-003-005	Fig. 5
019-003-006	Fig. 6
019-003-007	Fig. 7
019-003-008	Fig. 8
019-003-009	Fig. 9
019-003-010	Fig. 10
019-003-011	Fig. 11
019-003-012	Fig. 12
019-003-013	Fig. 13
019-003-014	Fig. 14
019-003-015	Fig. 15
019-003-016	Fig. 16

\*Mindestbestellmenge 5 Dutzend  
\*Minimum order quantity 5 dozen  
\*Cantidad mínima de pedido 5 docenas  
\*Quantità di ordine minimo 5 dozzine

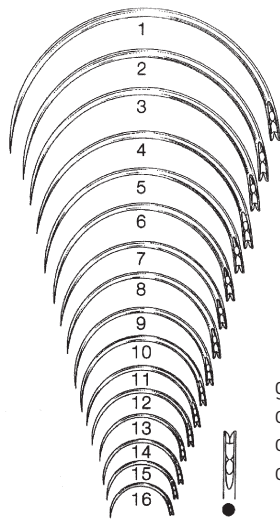

gebogen 1/2 Kreis  
curved 1/2 circle  
curvas 1/2 círculo  
curvi 1/2 circolo

**Gr**

<b>019-005-001</b>	Fig. 1
<b>019-005-002</b>	Fig. 2
<b>019-005-003</b>	Fig. 3
<b>019-005-004</b>	Fig. 4
<b>019-005-005</b>	Fig. 5
<b>019-005-006</b>	Fig. 6
<b>019-005-007</b>	Fig. 7
<b>019-005-008</b>	Fig. 8
<b>019-005-009</b>	Fig. 9
<b>019-005-010</b>	Fig. 10
<b>019-005-011</b>	Fig. 11
<b>019-005-012</b>	Fig. 12
<b>019-005-013</b>	Fig. 13
<b>019-005-014</b>	Fig. 14
<b>019-005-015</b>	Fig. 15
<b>019-005-016</b>	Fig. 16

\*in Packungen zu 12 Stück  
\*in packages of 12 pieces  
\*en paquetes de 12 piezas  
\*in confezione da 12 pezzi

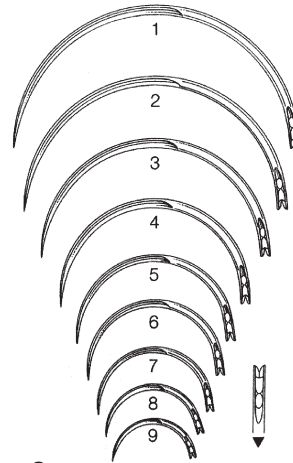

gebogen 1/2 Kreis  
curved 1/2 circle  
curvas 1/2 círculo  
curvi 1/2 circolo

**Ga**

<b>019-007-001</b>	Fig. 1
<b>019-007-002</b>	Fig. 2
<b>019-007-003</b>	Fig. 3
<b>019-007-004</b>	Fig. 4
<b>019-007-005</b>	Fig. 5
<b>019-007-006</b>	Fig. 6
<b>019-007-007</b>	Fig. 7
<b>019-007-008</b>	Fig. 8
<b>019-007-009</b>	Fig. 9

\*in Packungen zu 12 Stück  
\*in packages of 12 pieces  
\*en paquetes de 12 piezas  
\*in confezione da 12 pezzi

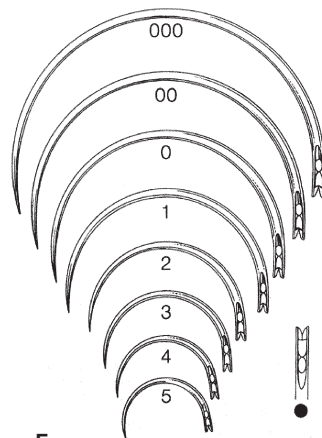

gebogen 1/2 Kreis  
curved 1/2 circle  
curvas 1/2 círculo  
curvi 1/2 circolo

**E**

<b>019-011-010</b>	Fig. 0
<b>019-011-020</b>	Fig. 00
<b>019-011-030</b>	Fig. 000
<b>019-013-001</b>	Fig. 1
<b>019-013-002</b>	Fig. 2
<b>019-013-003</b>	Fig. 3
<b>019-013-004</b>	Fig. 4
<b>019-013-005</b>	Fig. 5

\*in Packungen zu 12 Stück  
\*in packages of 12 pieces  
\*en paquetes de 12 piezas  
\*in confezione da 12 pezzi

\*Mindestbestellmenge 5 Dutzend  
\*Minimum order quantity 5 dozen  
\*Cantidad mínima de pedido 5 docenas  
\*Quantità di ordine minimo 5 dozzine

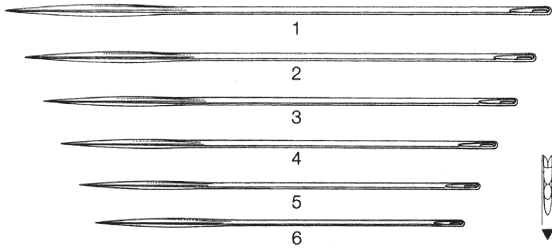

**KEITH**

- |                    |        |                            |
|--------------------|--------|----------------------------|
| <b>019-016-001</b> | Fig. 1 | *in Packungen zu 12 Stück  |
| <b>019-016-002</b> | Fig. 2 | *in packages of 12 pieces  |
| <b>019-016-003</b> | Fig. 3 | *en paquetes de 12 piezas  |
| <b>019-016-004</b> | Fig. 4 | *in confezione da 12 pezzi |
| <b>019-016-005</b> | Fig. 5 |                            |
| <b>019-016-006</b> | Fig. 6 |                            |

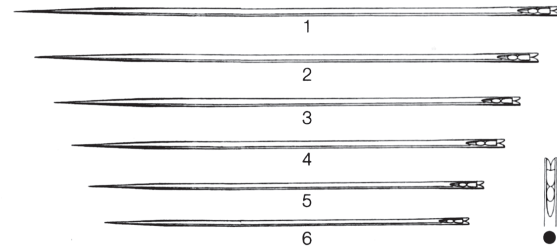

**KEITH**

- |                    |        |                            |
|--------------------|--------|----------------------------|
| <b>019-018-001</b> | Fig. 1 | *in Packungen zu 12 Stück  |
| <b>019-018-002</b> | Fig. 2 | *in packages of 12 pieces  |
| <b>019-018-003</b> | Fig. 3 | *en paquetes de 12 piezas  |
| <b>019-018-004</b> | Fig. 4 | *in confezione da 12 pezzi |
| <b>019-018-005</b> | Fig. 5 |                            |
| <b>019-018-006</b> | Fig. 6 |                            |

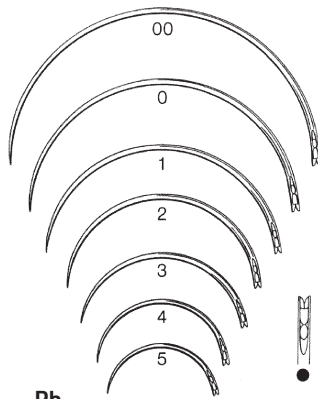

gebogen 1/2 Kreis  
curved 1/2 circle  
curvas 1/2 círculo  
curvi 1/2 circolo

**Pb**

- |                    |         |                            |
|--------------------|---------|----------------------------|
| <b>019-021-010</b> | Fig. 0  | *in Packungen zu 12 Stück  |
| <b>019-021-020</b> | Fig. 00 | *in packages of 12 pieces  |
| <b>019-023-001</b> | Fig. 1  | *en paquetes de 12 piezas  |
| <b>019-023-002</b> | Fig. 2  | *in confezione da 12 pezzi |
| <b>019-023-003</b> | Fig. 3  |                            |
| <b>019-023-004</b> | Fig. 4  |                            |
| <b>019-023-005</b> | Fig. 5  |                            |

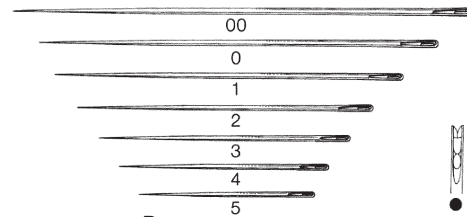

**Pc**

- |                    |         |                            |
|--------------------|---------|----------------------------|
| <b>019-024-010</b> | Fig. 0  | *in Packungen zu 12 Stück  |
| <b>019-024-020</b> | Fig. 00 | *in packages of 12 pieces  |
| <b>019-026-001</b> | Fig. 1  | *en paquetes de 12 piezas  |
| <b>019-026-002</b> | Fig. 2  | *in confezione da 12 pezzi |
| <b>019-026-003</b> | Fig. 3  |                            |
| <b>019-026-004</b> | Fig. 4  |                            |
| <b>019-026-005</b> | Fig. 5  |                            |

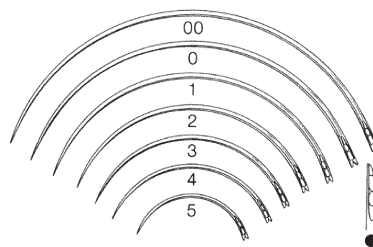

gebogen 3/8 Kreis  
curved 3/8 circle  
curvas 3/8 círculo  
curvi 3/8 circolo

**Pd**

- |                    |         |                            |
|--------------------|---------|----------------------------|
| <b>019-027-010</b> | Fig. 0  | *in Packungen zu 12 Stück  |
| <b>019-027-020</b> | Fig. 00 | *in packages of 12 pieces  |
| <b>019-029-001</b> | Fig. 1  | *en paquetes de 12 piezas  |
| <b>019-029-002</b> | Fig. 2  | *in confezione da 12 pezzi |
| <b>019-029-003</b> | Fig. 3  |                            |
| <b>019-029-004</b> | Fig. 4  |                            |
| <b>019-029-005</b> | Fig. 5  |                            |

\*Mindestbestellmenge 5 Dutzend  
\*Minimum order quantity 5 dozen  
\*Cantidad mínima de pedido 5 docenas  
\*Quantità di ordine minimo 5 dozzine

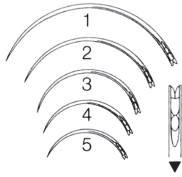

**Ob**

- 019-031-001** Fig. 1
- 019-031-002** Fig. 2
- 019-031-003** Fig. 3
- 019-031-004** Fig. 4
- 019-031-005** Fig. 5

gebogen 3/8 Kreis  
 curved 3/8 circle  
 curvas 3/8 circulo  
 curvi 3/8 circolo

- \*in Packungen zu 12 Stück
- \*in packages of 12 pieces
- \*en paquets de 12 piezas
- \*in confezione da 12 pezzi

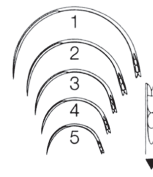

**Og**

- 019-033-001** Fig. 1
- 019-033-002** Fig. 2
- 019-033-003** Fig. 3
- 019-033-004** Fig. 4
- 019-033-005** Fig. 5

gebogen 1/2 Kreis  
 curved 1/2 circle  
 curvas 1/2 circulo  
 curvi 1/2 circolo

- \*in Packungen zu 12 Stück
- \*in packages of 12 pieces
- \*en paquets de 12 piezas
- \*in confezione da 12 pezzi

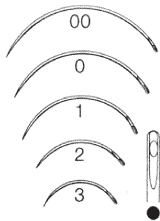

**KALT**

- 019-035-010** Fig. 0
- 019-035-020** Fig. 00
- 019-037-001** Fig. 1
- 019-037-002** Fig. 2
- 019-037-003** Fig. 3

gebogen 3/8 Kreis  
 curved 3/8 circle  
 curvas 3/8 circulo  
 curvi 3/8 circolo

- \*in Packungen zu 12 Stück
- \*in packages of 12 pieces
- \*en paquets de 12 piezas
- \*in confezione da 12 pezzi

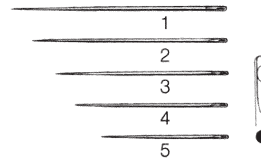

**PAYR**

- 019-040-001** Fig. 1
- 019-040-002** Fig. 2
- 019-040-003** Fig. 3
- 019-040-004** Fig. 4
- 019-040-005** Fig. 5

- \*in Packungen zu 12 Stück
- \*in packages of 12 pieces
- \*en paquets de 12 piezas
- \*in confezione da 12 pezzi

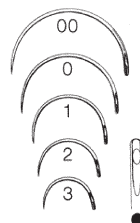

gebogen 1/2 Kreis  
 curved 1/2 circle  
 curvas 1/2 circulo  
 curvi 1/2 circolo

**PAYR**

- 019-043-010** Fig. 0
- 019-043-020** Fig. 00
- 019-045-001** Fig. 1
- 019-045-002** Fig. 2
- 019-045-003** Fig. 3

- \*in Packungen zu 12 Stück
- \*in packages of 12 pieces
- \*en paquets de 12 piezas
- \*in confezione da 12 pezzi

\*Mindestbestellmenge 5 Dutzend  
 \*Minimum order quantity 5 dozen  
 \*Cantidad mínima de pedido 5 docenas  
 \*Quantità di ordine minimo 5 dozzine



019

Nadelkassetten  
Needle Cases  
Estuches para agujas  
Scatole per aghi



**019-070-001** 150x95x13 mm



**019-070-002** 150x95x13 mm  
perforierter Deckel und Boden  
perforated lid and bottom  
tapa y fondo perforado  
coperchio e fondo perforati



**019-070-003** 150x95x13 mm  
perforierter Boden  
perforated bottom  
fondo perforado  
fondo perforato



---

**019-070-005** 150x95x13 mm



---

**019-070-006** 150x95x13 mm

perforierter Deckel und Boden  
perforated lid and bottom  
tapa y fondo perforado  
coperchio e fondo perforati



019

Nadelkassetten  
Needle Cases  
Estuches para agujas  
Scatole per aghi

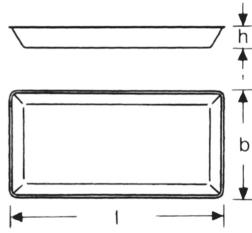
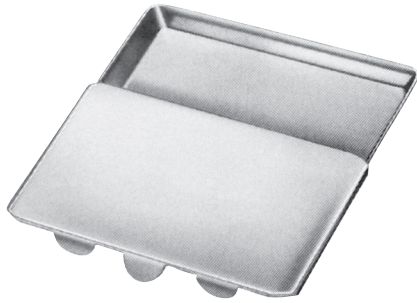

**019-074-050** 50x25x4,5 mm  
**019-074-065** 65x42x8,0 mm  
**019-074-075** 75x25x4,5 mm

**019-076-050** 50x25x4,5 mm  
**019-076-065** 65x42x8,0 mm  
**019-076-075** 75x25x4,5 mm



**019-080-001** Ø 62x13 mm  
Innendose allein, perforiert  
Interior box, perforated  
Caja interior, perforada  
Scatola interiore, perforati

**019-080-000** Ø 65x15 mm



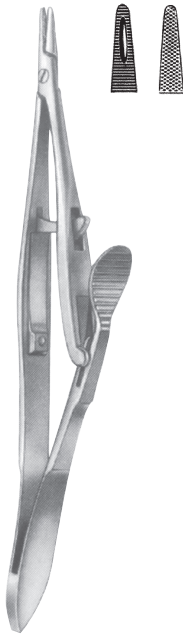

**KALT**

**019-100-140** 14,0 cm / 5 1/2"



**019-104-140**

**019-105-140**

**ARRUGA**

**019-104-140 - 019-105-140** 14,0 cm / 5 1/2"



**019-106-160**

**019-107-160**

**ARRUGA**

**019-106-160 - 019-107-160** 16,0 cm / 6 1/4"



019

Mikro-Nadelhalter  
Micro Needle Holders  
Micro Porta-agujas  
Micro Portaghi

Maul 0,5 mm  
jaw 0,5 mm  
boca 0,5 mm  
muso 0,5 mm



019-108-100



019-109-100

ohne Sperre  
without ratchet  
sin cierre  
senza chiusura

Maul 0,5 mm  
jaw 0,5 mm  
boca 0,5 mm  
muso 0,5 mm



019-110-100



019-111-100

mit Sperre  
with ratchet  
con cierre  
con chiusura

**BARRAQUER-TROUTMAN**

019-108-100 - 019-109-100

10,0 cm / 4"

**BARRAQUER-TROUTMAN**

019-110-100 - 019-111-100

10,0 cm / 4"

Maul 1,0 mm  
jaw 1,0 mm  
boca 1,0 mm  
muso 1,0 mm

glatt  
smooth  
liso  
liscio



019-112-115



019-112-130



019-112-140



019-113-115



019-113-130



019-113-140

ohne Sperre  
without ratchet  
sin cierre  
senza chiusura

Maul 1,0 mm  
jaw 1,0 mm  
boca 1,0 mm  
muso 1,0 mm

glatt  
smooth  
liso  
liscio



019-114-115



019-114-130



019-114-140



019-115-115



019-115-130



019-115-140

mit Sperre  
with ratchet  
con cierre  
con chiusura

**BARRAQUER**

019-112-115 - 019-113-115

11,5 cm / 4 1/2"

019-112-130 - 019-113-130

13,0 cm / 5 1/8"

019-112-140 - 019-113-140

14,0 cm / 5 1/2"

**BARRAQUER**

019-114-115 - 019-115-115

11,5 cm / 4 1/2"

019-114-130 - 019-115-130

13,0 cm / 5 1/8"

019-114-140 - 019-115-140

14,0 cm / 5 1/2"

Maul 1,0 mm  
 jaw 1,0 mm  
 boca 1,0 mm  
 muso 1,0 mm



glatt  
 smooth  
 liso  
 liscio

mit Sperre  
 with ratchet  
 con cierre  
 con chiusura

Maul 1,0 mm  
 jaw 1,0 mm  
 boca 1,0 mm  
 muso 1,0 mm



glatt  
 smooth  
 liso  
 liscio

mit Sperre  
 with ratchet  
 con cierre  
 con chiusura

**BARRAQUER**

**019-120-150** 15,0 cm / 6"  
**019-120-180** 18,0 cm / 6"  
**019-120-210** 21,0 cm / 8 1/4"

**BARRAQUER**

**019-121-150** 15,0 cm / 6"  
**019-121-180** 18,0 cm / 6"  
**019-121-210** 21,0 cm / 8 1/4"

Maul 1,0 mm  
 jaw 1,0 mm  
 boca 1,0 mm  
 muso 1,0 mm



glatt  
 smooth  
 liso  
 liscio

ohne Sperre  
 without ratchet  
 sin cierre  
 senza chiusura

Maul 1,0 mm  
 jaw 1,0 mm  
 boca 1,0 mm  
 muso 1,0 mm



glatt  
 smooth  
 liso  
 liscio

ohne Sperre  
 without ratchet  
 sin cierre  
 senza chiusura



gebogen  
 curved  
 curva  
 curva

ohne Sperre  
 without ratchet  
 sin cierre  
 senza chiusura

**BARRAQUER**

**019-124-150** 15,0 cm / 6"  
**019-124-180** 18,0 cm / 6"

**BARRAQUER**

**019-125-150** 15,0 cm / 6"  
**019-125-180** 18,0 cm / 6"

**GOMEL**

**019-127-140** 14,0 cm / 5 1/2"



019

Mikro-Nadelhalter  
Micro Needle Holders  
Micro Porta-agujas  
Micro Portaghi



019-130-140



019-131-140

mit Sperre  
with ratchet  
con cierre  
con chiusura

**CASTROVIEJO**

019-130-140 - 019-131-140 14,0 cm / 5 1/2"



019-132-140



019-133-140

ohne Sperre  
without ratchet  
sin cierre  
senza chiusura

**CASTROVIEJO**

019-132-140 - 019-133-140 14,0 cm / 5 1/2"



019-136-140



019-137-140

mit Sperre  
with ratchet  
con cierre  
con chiusura

**CASTROVIEJO**

019-136-140 - 019-137-140 14,0 cm / 5 1/2"



019-138-140



019-139-140

ohne Sperre  
without ratchet  
sin cierre  
senza chiusura

**CASTROVIEJO**

019-138-140 - 019-139-140 14,0 cm / 5 1/2"



mit Sperre  
 with ratchet  
 con cierre  
 con chiusura

**CASTROVIEJO (JACOBSON)**

**019-144-180** 18,0 cm / 7"  
**019-144-210** 21,0 cm / 8<sup>1</sup>/<sub>4</sub>"



mit Sperre  
 with ratchet  
 con cierre  
 con chiusura

**CASTROVIEJO (JACOBSON)**

**019-145-180** 18,0 cm / 7"  
**019-145-210** 21,0 cm / 8<sup>1</sup>/<sub>4</sub>"



mit Sperre  
 with ratchet  
 con cierre  
 con chiusura

**CASTROVIEJO (JACOBSON)**

**019-146-180** 18,0 cm / 7"  
**019-146-210** 21,0 cm / 7"



mit Sperre  
 with ratchet  
 con cierre  
 con chiusura

**CASTROVIEJO (JACOBSON)**

**019-147-180** 18,0 cm / 7"  
**019-147-210** 21,0 cm / 7"



ohne Sperre  
 without ratchet  
 sin cierre  
 senza chiusura

**CASTROVIEJO (JACOBSON)**

**019-148-180** 18,0 cm / 7"  
**019-148-210** 21,0 cm / 7"



ohne Sperre  
 without ratchet  
 sin cierre  
 senza chiusura

**CASTROVIEJO (JACOBSON)**

**019-149-180** 18,0 cm / 7"  
**019-149-210** 21,0 cm / 7"



ohne Sperre  
 without ratchet  
 sin cierre  
 senza chiusura

**CASTROVIEJO (JACOBSON)**

**019-150-180** 18,0 cm / 7"  
**019-150-210** 21,0 cm / 7"



ohne Sperre  
 without ratchet  
 sin cierre  
 senza chiusura

**CASTROVIEJO (JACOBSON)**

**019-151-180** 18,0 cm / 7"  
**019-151-210** 21,0 cm / 7"



019

Mikro-Nadelhalter  
Micro Needle Holders  
Micro Porta-agujas  
Micro Portaghi



glatt  
smooth  
liso  
liscio

ohne Sperre  
without ratchet  
sin cierre  
senza chiusura

**YASARGIL**

**019-170-200** 20,0 cm / 8"  
**019-170-225** 22,5 cm / 9"  
**019-170-245** 24,5 cm / 9<sup>2</sup>/<sub>3</sub>"



glatt  
smooth  
liso  
liscio

ohne Sperre  
without ratchet  
sin cierre  
senza chiusura

**YASARGIL**

**019-171-200** 20,0 cm / 8"  
**019-171-225** 22,5 cm / 9"  
**019-171-245** 24,5 cm / 9<sup>2</sup>/<sub>3</sub>"



glatt  
smooth  
liso  
liscio

**CASTROVIEJO**

**019-186-130** 13,0 cm / 5<sup>1</sup>/<sub>8</sub>"

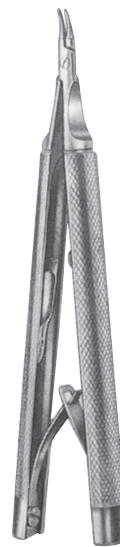

glatt  
smooth  
liso  
liscio

**CASTROVIEJO**

**019-187-130** 13,0 cm / 5<sup>1</sup>/<sub>8</sub>"



**DERF**

**019-200-125** 13,0 cm / 5<sup>1</sup>/<sub>8</sub>"



**DERF**

**019-202-125** 12,5 cm / 5"



**COLLIER**

**019-204-125** 12,5 cm / 5"

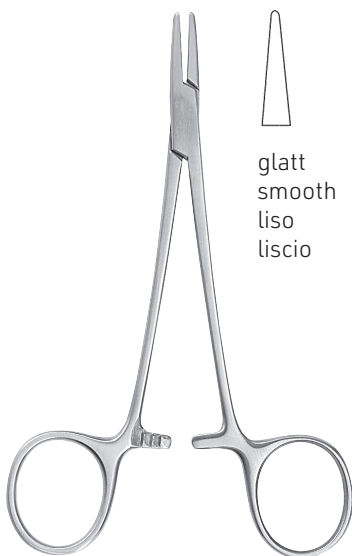

glatt  
smooth  
liso  
liscio

**WEBSTER**

**019-210-130** 13,0 cm / 5"



gerieft  
serrated  
estriado  
striato

**WEBSTER**

**019-212-130** 13,0 cm / 5"



glatt  
smooth  
liso  
liscio

**HALSEY**

**019-216-115** 11,5 cm / 4"  
**019-216-130** 13,0 cm / 5<sup>1</sup>/<sub>8</sub>"



019

Nadelhalter  
Needle Holders  
Porta-agujas  
Portaghi



**HALSEY**

**019-218-130** 13,0 cm / 5<sup>1</sup>/<sub>8</sub>"



glattes Maul mit Spezialkehlung  
smooth jaw, special groove  
boca lisa, especialmente acanalada  
mors lisse, avec stries spéciales  
morso liscio con scannellatura speciale

**NEIVERT**

**019-220-130** 13,0 cm / 5<sup>1</sup>/<sub>8</sub>"



**BAUMGARTNER**

**019-224-140** 14,0 cm / 5<sup>1</sup>/<sub>2</sub>"



**BROWN**

**019-226-130** 13,0 cm / 5<sup>1</sup>/<sub>8</sub>"  
**019-226-180** 18,0 cm / 7"





**CRILE MURRAY**  
**019-228-150** 15,0 cm / 6"



**CRILE WOOD**  
**019-230-150** 15,0 cm / 6"  
**019-230-180** 18,0 cm / 7"  
**019-230-200** 20,0 cm / 8"



**ADSON**  
**019-232-180** 18,0 cm / 7"



**METZENBAUM**  
**019-234-180** 18,0 cm / 7"



**MASS.-GENERAL-HOSPITAL**  
**019-236-170** 17,0 cm / 6<sup>3</sup>/<sub>4</sub>"



019

Nadelhalter  
Needle Holders  
Porta-agujas  
Portaghi



019-240-125



019-240-140

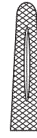

019-240-160

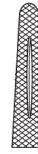

019-240-180

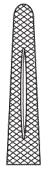

019-240-200

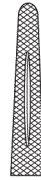

019-240-240

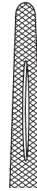

019-240-260



019-240-300

**MAYO-HEGAR**

<b>019-240-125</b>	12,5 cm / 5"
<b>019-240-140</b>	14,0 cm / 5 1/2"
<b>019-240-160</b>	16,0 cm / 6 1/4"
<b>019-240-180</b>	18,0 cm / 7"
<b>019-240-200</b>	20,0 cm / 8"
<b>019-240-240</b>	24,0 cm / 9 1/2"
<b>019-240-260</b>	26,0 cm / 10 1/4"
<b>019-240-300</b>	30,0 cm / 11 3/4"



019-242-160



019-242-180



019-242-200

schlankes Modell  
delicate pattern  
modelo delgado  
modello gracile

**MAYO HEGAR**

<b>019-242-160</b>	16,0 cm / 6 1/4"
<b>019-242-180</b>	18,0 cm / 7"
<b>019-242-200</b>	20,0 cm / 8"



**HEANEY**

**019-245-210** 21,0 cm / 8<sup>1</sup>/<sub>4</sub>"



**JAMISON**

**019-248-235** 23,5 cm / 9<sup>1</sup>/<sub>4</sub>"



**MASSON**

**019-250-270** 27,0 cm / 10<sup>1</sup>/<sub>2</sub>"



019

Nadelhalter  
Needle Holders  
Porta-agujas  
Portaghi



**FINOCHIETTO**

**019-253-270** 27,0 cm / 10½"



**WANGENSTEEN**

**019-256-270** 27,0 cm / 10½"



**JOHNSON**

**019-257-270** 27,0 cm / 10½"

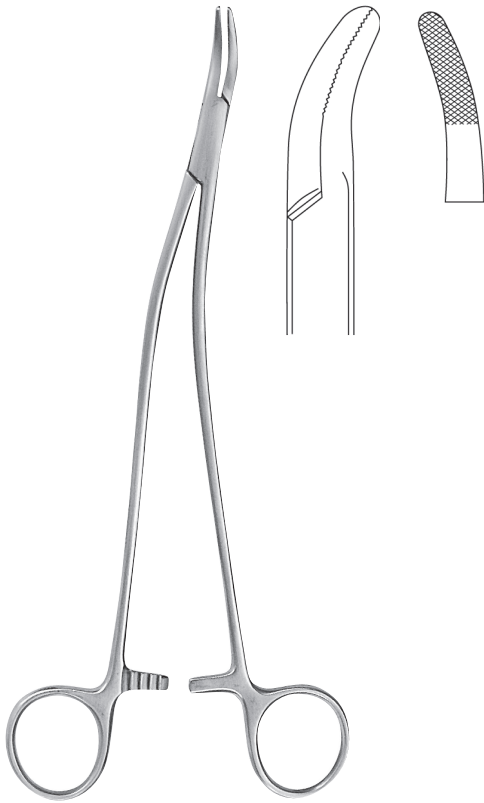

**STRATTE**

**019-259-230** 23,0 cm / 9"



**MAYO-HEGAR**

**019-260-165** 16,5 cm / 6 1/2"  
**019-260-190** 19,0 cm / 7 1/2"



**HEGAR**

**019-262-150** 15,0 cm / 6"  
**019-262-175** 17,5 cm / 7"  
**019-262-205** 20,5 cm / 8"

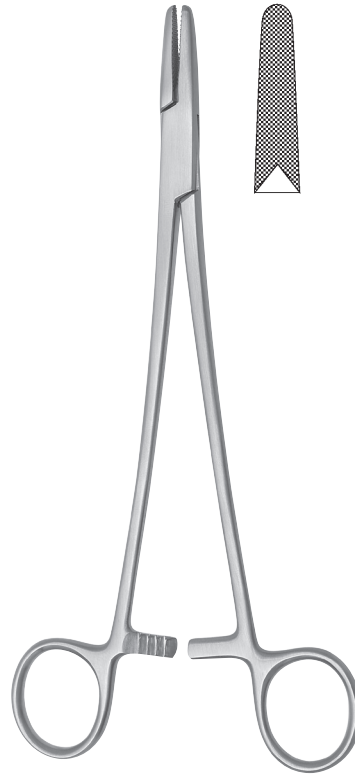

**HEGAR**

**019-264-205** 20,5 cm / 8"



019

Nadelhalter  
Needle Holders  
Porta-agujas  
Portaghi

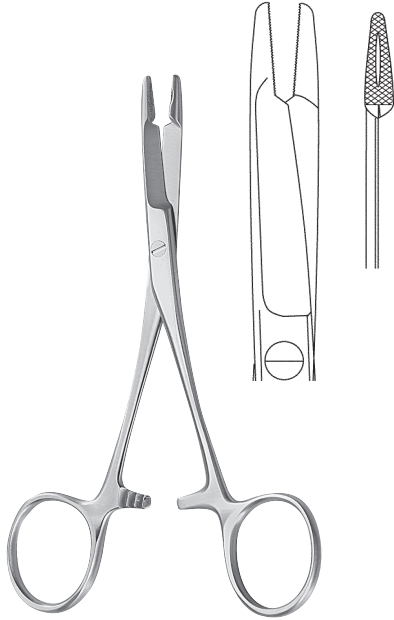

**OLSEN-HEGAR**

**019-270-115** 11,5 cm / 4 1/2"  
**019-270-140** 14,0 cm / 5 1/2"

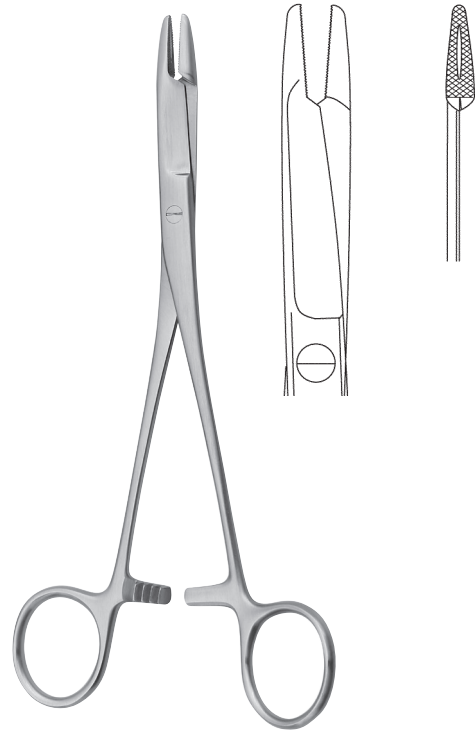

**OLSEN-HEGAR**

**019-272-185** 18,5 cm / 7 1/4"

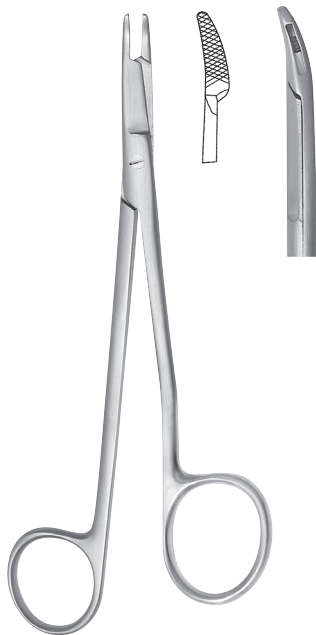

**BABY-GILLIES**

**019-274-150** 15,0 cm / 6"



**GILLIES**

**019-276-160** 16,0 cm / 6 1/4"

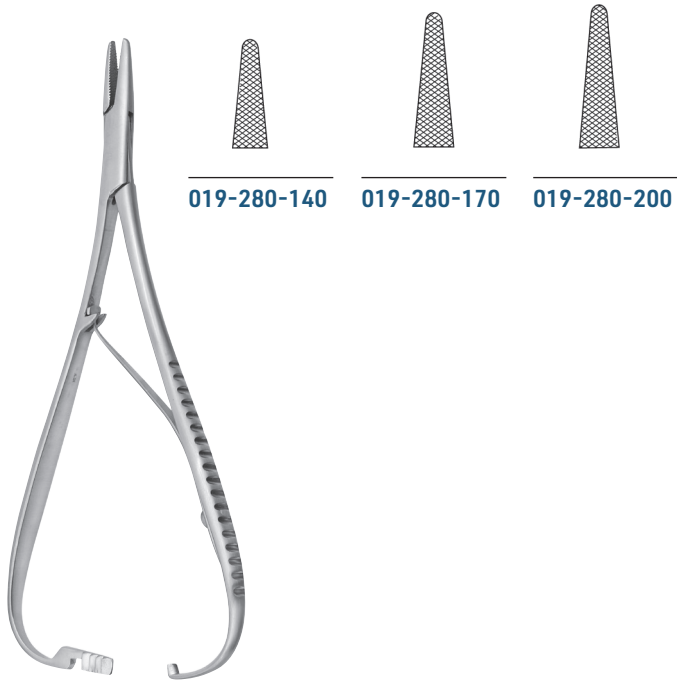

**MATHIEU**

**019-280-140** 14,0 cm / 5½"  
**019-280-170** 17,0 cm / 6¾"  
**019-280-200** 20,0 cm / 8"

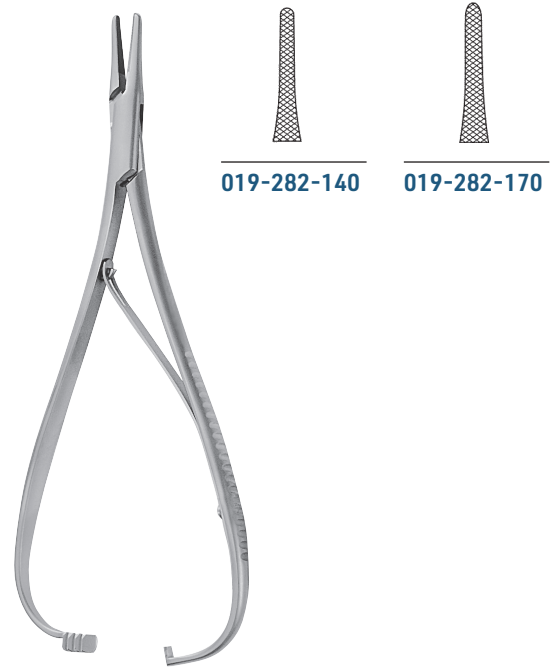

**MATHIEU-KOCHER**

**019-282-140** 14,0 cm / 5½"  
**019-282-170** 17,0 cm / 6¼"



**MATHIEU-RYDER**

**019-286-140** 14,0 cm / 5½"



**TOENNIS**

**019-290-180** 18,0 cm / 7"



**LICHTENBERG**

**019-292-200** 20,0 cm / 8"



019

Nadelhalter mit Hartmetalleinlagen  
Needle Holders with tungsten carbide inserts  
Porta-agujas con bocas de carburo tungsteno  
Portaghi con morsi in carburo di tungsteno

Hartmetalleinlagen mit präzis gearbeitetem Pyramidenprofil garantieren einen sicheren Halt der Nadel.

Tungsten carbide inserts with precisely worked out structure guarantee to grip the needle securely.

Capas intermedias de carburo tungsteno con perfil amoldado piramidal que garantiza un sujeto seguro de la aguja.

Inserti in carburo di tungsteno che garantiscono una perfetta tenuta dell'ago.

Gebrochene Kanten verhindern ein Verfangen des Nahtmaterials.

Bevelled edges to prevent catching of suture material.

Bordes quebrados evitan que se enrede el material de sutura.

I bordi squadrati evitano che si impigliano i fili di sutura.

Vergoldete Ringe als leichte Kennzeichnung.

Gold-plated rings for easy identification.

Anillos dorados para fácil identificación

Anelli dorata permette una facile identificazione.

Leichtgängige Sperre ermöglicht eine sichere Arbeitsweise.

Soft working catch provides safe handling.

El cierre suave facilita un manejo seguro.

Il bloccaggio leggero e preciso facilita un uso sicuro.

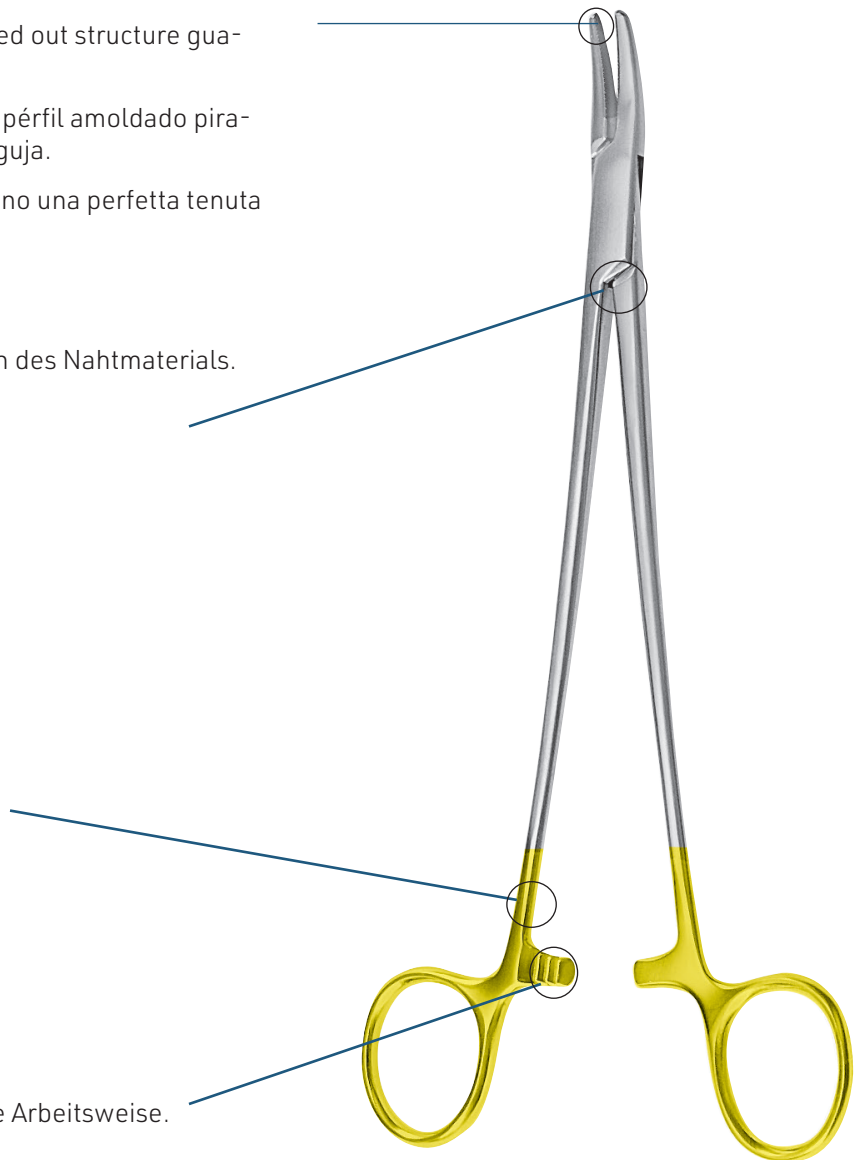



Je nach Anwendungsgebiet stehen für TC Nadelhalter unterschiedliche Hartmetalleinlagen zur Verfügung:  
According to the field of application, there are various types of tungsten carbide inserts for TC needle holders:  
Según campo de aplicación, disponemos de TC porta-agujas con varias capas intermedias:  
A seconda delle necessità disponiamo di TC portaghi con varie capacità intermedie:

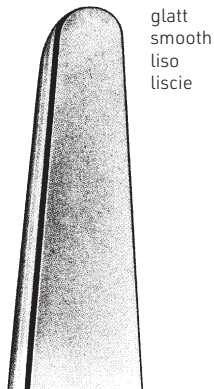

Zum Halten von extrem feinem Nahtmaterial.  
For holding the smallest suture sizes.  
Para sujetar suturas muy finas.  
Per lavorare con suture sottilissime

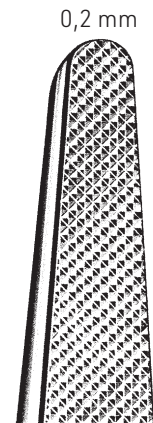

Zum Halten von Nahtmaterial der Stärken 7/0 bis 10/0.  
For holding the suture sizes from 7/0 to 10/0.  
Para sujetar suturas de gruesas 7/0 hasta 10/0.  
Per lavorare con suture da 7/0 a 10/0.

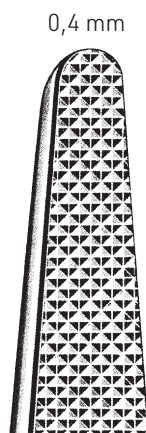

Zum Halten von Nahtmaterial der Stärken 4/0 bis 6/0.  
For holding the suture sizes from 4/0 to 6/0.  
Para sujetar suturas de gruesas 4/0 hasta 6/0.  
Per lavorare con suture da 4/0 a 6/0.

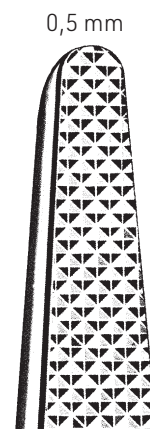

Zum Halten von Nahtmaterial der Stärke 3/0 und kräftiger.  
For holding the suture size 3/0 and larger.  
Para sujetar suturas de 3/0 y más gruesas.  
Per lavorare con suture da 3/0 in poi.



019

Nadelhalter mit Hartmetalleinlagen  
Needle Holders with tungsten carbide inserts  
Porta-agujas con bocas de carburo tungsteno  
Portaghi con morsi in carburo di tungsteno



**KALT**

**019-300-140** 14,0 cm / 5<sup>1</sup>/<sub>2</sub>"



**019-304-160**



**019-305-160**

**ARRUGA**

**019-304-160 - 019-305-160** 16,0 cm / 6<sup>1</sup>/<sub>4</sub>"



**BOYTON**

**019-310-120** 12,0 cm / 4<sup>3</sup>/<sub>4</sub>"



ohne Sperre  
 without ratchet  
 sin cierre  
 senza chiusura

**CASTROVIEJO (JACOBSON)**

- 019-320-140** 14,0 cm / 5 1/2"
- 019-320-180** 18,0 cm / 7"
- 019-320-220** 22,0 cm / 8 3/4"



ohne Sperre  
 without ratchet  
 sin cierre  
 senza chiusura

**CASTROVIEJO (JACOBSON)**

- 019-321-140** 14,0 cm / 5 1/2"
- 019-321-180** 18,0 cm / 7"
- 019-321-220** 22,0 cm / 8 3/4"



ohne Sperre  
 without ratchet  
 sin cierre  
 senza chiusura

**CASTROVIEJO (JACOBSON)**

- 019-330-140** 14,0 cm / 5 1/2"
- 019-330-180** 18,0 cm / 7"
- 019-330-220** 22,0 cm / 8 3/4"



ohne Sperre  
 without ratchet  
 sin cierre  
 senza chiusura

**CASTROVIEJO (JACOBSON)**

- 019-331-140** 14,0 cm / 5 1/2"
- 019-331-180** 18,0 cm / 7"
- 019-331-220** 22,0 cm / 8 3/4"



mit Sperre  
 with ratchet  
 con cierre  
 con chiusura

**CASTROVIEJO (JACOBSON)**

- 019-340-140** 14,0 cm / 5 1/2"
- 019-340-180** 18,0 cm / 7"
- 019-340-220** 22,0 cm / 8 3/4"



mit Sperre  
 with ratchet  
 con cierre  
 con chiusura

**CASTROVIEJO (JACOBSON)**

- 019-341-140** 14,0 cm / 5 1/2"
- 019-341-180** 18,0 cm / 7"
- 019-341-220** 22,0 cm / 8 3/4"



019

Nadelhalter mit Hartmetalleinlagen  
Needle Holders with tungsten carbide inserts  
Porta-agujas con bocas de carburo tungsteno  
Portaghi con morsi in carburo di tungsteno



**CASTROVIEJO (JACOBSON)**

**019-350-140** 14,0 cm / 5 1/2"  
**019-350-180** 18,0 cm / 7"  
**019-350-220** 22,0 cm / 8 3/4"



**CASTROVIEJO (JACOBSON)**

**019-351-140** 14,0 cm / 5 1/2"  
**019-351-180** 18,0 cm / 7"  
**019-351-220** 22,0 cm / 8 3/4"



**019-360-180**



**019-361-180**

**BARRAQUER**

**019-360-180 - 019-361-180** 18,0 cm / 7"



**BARRAQUER**

**019-370-180** 18,0 cm / 7"



**BARRAQUER**

**019-371-140** 14,0 cm / 5 1/2"  
**019-371-180** 18,0 cm / 7"



**BARRAQUER**  
**019-380-180** 18,0 cm / 7"  
**019-380-210** 21,0 cm / 8<sup>1</sup>/<sub>4</sub>"



**BARRAQUER**  
**019-381-180** 18,0 cm / 7"  
**019-381-210** 21,0 cm / 8<sup>1</sup>/<sub>4</sub>"



**BARRAQUER**  
**019-390-180** 18,0 cm / 7"  
**019-390-210** 21,0 cm / 8<sup>1</sup>/<sub>4</sub>"



**BARRAQUER**  
**019-391-140** 14,0 cm / 5<sup>1</sup>/<sub>2</sub>"  
**019-391-180** 18,0 cm / 7"  
**019-391-210** 21,0 cm / 8<sup>1</sup>/<sub>4</sub>"



diamantbeschichtet  
 diamond coated  
 capa de diamante  
 strato di diamante

**YASARGIL**  
**019-400-225** 22,5 cm / 9"



diamantbeschichtet  
 diamond coated  
 capa de diamante  
 strato di diamante

ohne Sperre  
 without ratchet  
 sub cierre  
 senza chiusura

**YASARGIL**  
**019-401-225** 22,5 cm / 9"



019

Nadelhalter mit Hartmetalleinlagen  
Needle Holders with tungsten carbide inserts  
Porta-agujas con bocas de carburo tungsteno  
Portaghi con morsi in carburo di tungsteno



**DIETHRICH**

- 019-410-160** 16,0 cm / 6<sup>1</sup>/<sub>4</sub>"
- 019-410-180** 18,0 cm / 7"
- 019-410-200** 20,0 cm / 8"
- 019-410-230** 23,0 cm / 9"
- 019-410-250** 25,0 cm / 9<sup>3</sup>/<sub>4</sub>"



**DIETHRICH**

- 019-420-160** 16,0 cm / 6<sup>1</sup>/<sub>4</sub>"
- 019-420-180** 18,0 cm / 7"
- 019-420-200** 20,0 cm / 8"
- 019-420-230** 23,0 cm / 9"
- 019-420-250** 25,0 cm / 9<sup>3</sup>/<sub>4</sub>"

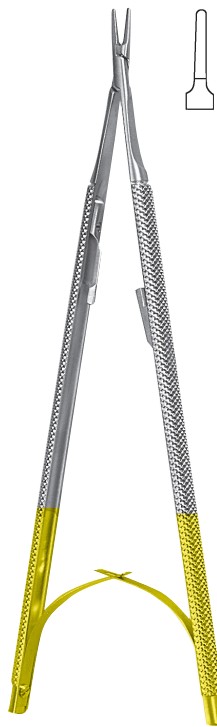

**HEPP-SCHEIDEL**

- 019-430-180** 18,0 cm / 7"



**DERF**

- 019-500-120** 12,0 cm / 4<sup>3</sup>/<sub>4</sub>"



**CONVERSE**

**019-504-120** 12,0 cm / 4<sup>3</sup>/<sub>4</sub>"

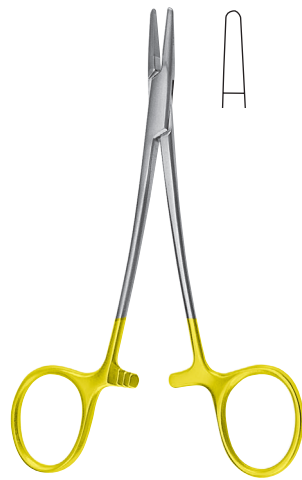

**WEBSTER**

**019-510-115** 11,5 cm / 4<sup>1</sup>/<sub>2</sub>"  
**019-510-130** 13,0 cm / 5<sup>1</sup>/<sub>8</sub>"

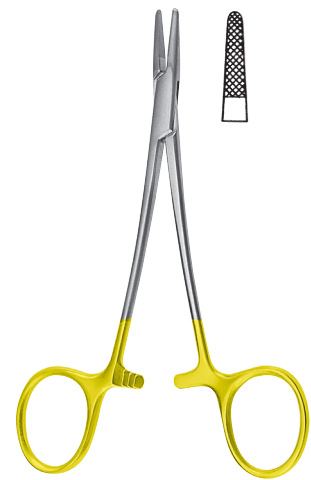

**WEBSTER**

**019-511-130** 13,0 cm / 5<sup>1</sup>/<sub>8</sub>"

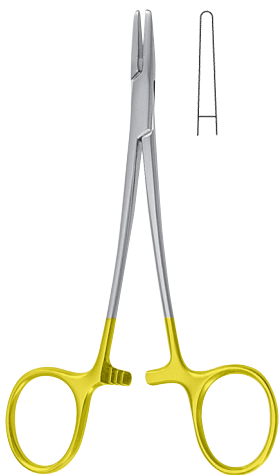

**HALSEY**

**019-520-130** 13,0 cm / 5<sup>1</sup>/<sub>8</sub>"



**HALSEY**

**019-522-115** 11,5 cm / 4<sup>1</sup>/<sub>2</sub>"  
**019-522-130** 13,0 cm / 5<sup>1</sup>/<sub>8</sub>"



**NEIVERT**

**019-530-130** 13,0 cm / 5<sup>1</sup>/<sub>8</sub>"



019

Nadelhalter mit Hartmetalleinlagen  
Needle Holders with tungsten carbide inserts  
Porta-agujas con bocas de carburo tungsteno  
Portaghi con morsi in carburo di tungsteno

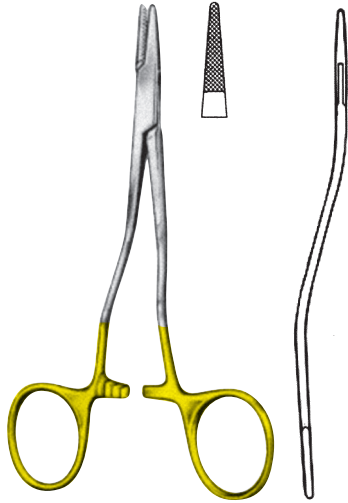

**KILNER**

**019-535-135** 13,5 cm / 5 1/4"



**BAUMGARTNER**

**019-540-125** 12,5 cm / 5"  
**019-540-140** 14,0 cm / 5 1/2"



**019-550-140**



**019-550-160**



**019-550-180**



**019-550-200**



**019-550-240**



**019-550-260**



**019-550-300**



**MAYO-HEGAR**

**019-550-140** 14,0 cm / 5 1/2"  
**019-550-160** 16,0 cm / 6 1/4"  
**019-550-180** 18,0 cm / 7"  
**019-550-200** 20,0 cm / 8"  
**019-550-240** 24,0 cm / 9 1/2"  
**019-550-260** 26,0 cm / 10 1/4"  
**019-550-300** 30,0 cm / 11 3/4"



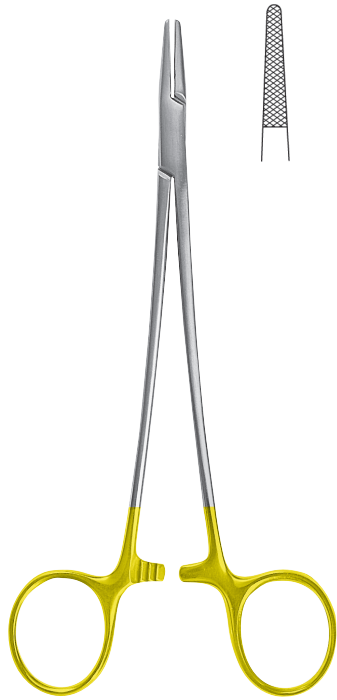

**MAYO-HEGAR - SLENDER PATTERN**

**019-552-180** 18,0 cm / 7"  
**019-552-200** 20,0 cm / 8"

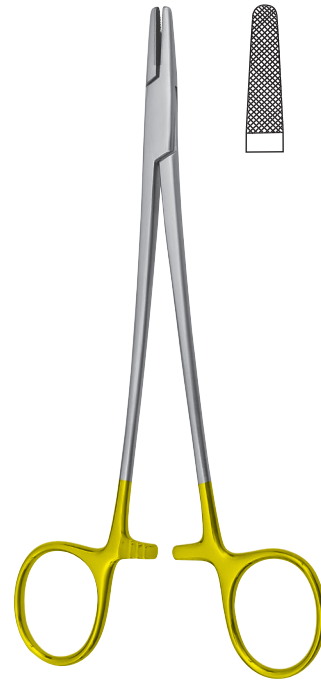

**MAYO-HEGAR - HEAVY PATTERN**

**019-554-180** 18,0 cm / 7"



**HEGAR**

**019-556-200** 20,0 cm / 8"  
**019-556-240** 24,0 cm / 9<sup>5</sup>/<sub>8</sub>"



**MAYO-HEGAR (HEANEY)**

**019-557-200** 20,0 cm / 8"  
**019-557-240** 24,0 cm / 9<sup>5</sup>/<sub>8</sub>"  
**019-557-260** 26,0 cm / 10<sup>1</sup>/<sub>4</sub>"

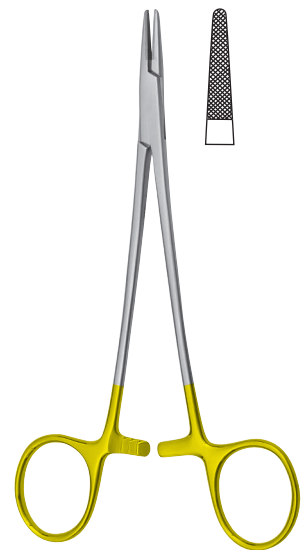

**CRILE-WOOD BABY**

**019-560-150** 15,0 cm / 6"



019

Nadelhalter mit Hartmetalleinlagen  
 Needle Holders with tungsten carbide inserts  
 Porta-agujas con bocas de carburo tungsteno  
 Portaghi con morsi in carburo di tungsteno

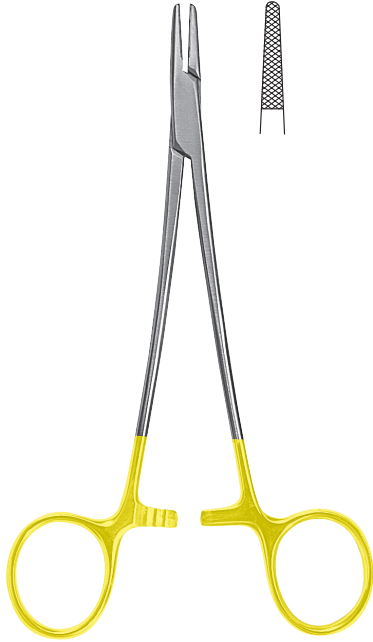

**CRILE-WOOD**

- 019-570-150** 15,0 cm / 6"
- 019-570-180** 18,0 cm / 7"
- 019-570-200** 20,0 cm / 8"
- 019-570-230** 23,0 cm / 9"
- 019-570-260** 26,0 cm / 10<sup>1</sup>/<sub>4</sub>"

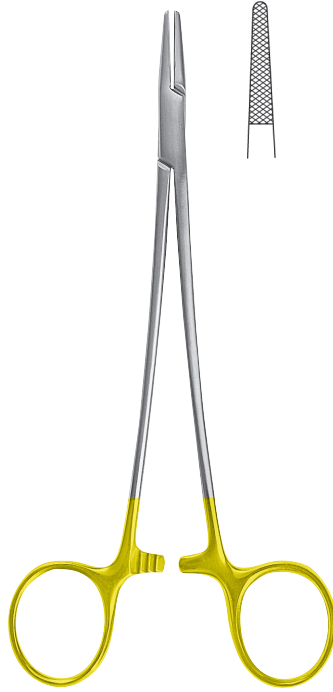

**DEBAKEY**

- 019-580-150** 15,0 cm / 6"
- 019-580-165** 16,5 cm / 6<sup>1</sup>/<sub>2</sub>"
- 019-580-180** 18,0 cm / 7"
- 019-580-200** 20,0 cm / 8"
- 019-580-230** 23,0 cm / 9"
- 019-580-260** 26,0 cm / 10<sup>1</sup>/<sub>4</sub>"
- 019-580-310** 31,0 cm / 12<sup>1</sup>/<sub>4</sub>"

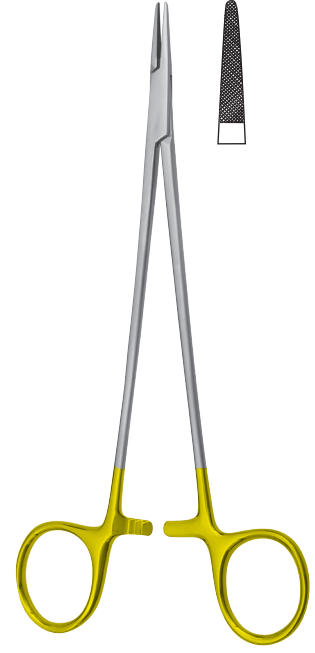

**MIKRO-SLIM**

- 019-586-150** 15,0 cm / 6"
- 019-586-180** 18,0 cm / 7"
- 019-586-200** 20,0 cm / 8"
- 019-586-230** 23,0 cm / 9"

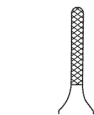
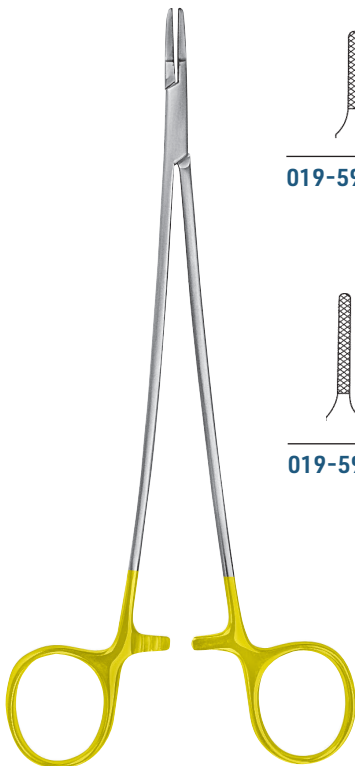

**019-590-130**

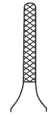

**019-590-150**

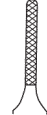

**019-590-180**

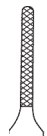

**019-590-200**

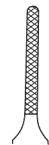

**019-590-230**

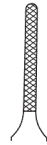

**019-590-260**

**RYDER-FRENCH EYE**

- 019-590-130** 13,0 cm / 5<sup>1</sup>/<sub>8</sub>"
- 019-590-150** 15,0 cm / 6"
- 019-590-180** 18,0 cm / 7"
- 019-590-200** 20,0 cm / 8"
- 019-590-230** 23,0 cm / 9"
- 019-590-260** 26,0 cm / 10<sup>1</sup>/<sub>4</sub>"

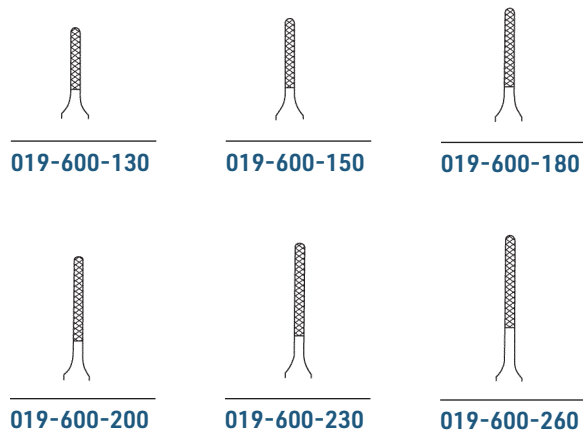

**RYDER-MINI**

<b>019-600-130</b>	13,0 cm / 5 <sup>1</sup> / <sub>8</sub> "
<b>019-600-150</b>	15,0 cm / 6"
<b>019-600-180</b>	18,0 cm / 7"
<b>019-600-200</b>	20,0 cm / 8"
<b>019-600-230</b>	23,0 cm / 9"
<b>019-600-260</b>	26,0 cm / 10 <sup>1</sup> / <sub>4</sub> "

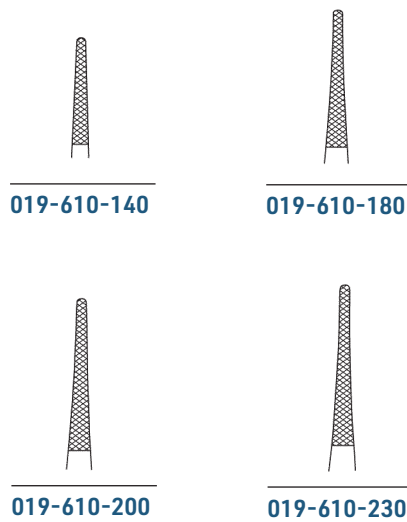
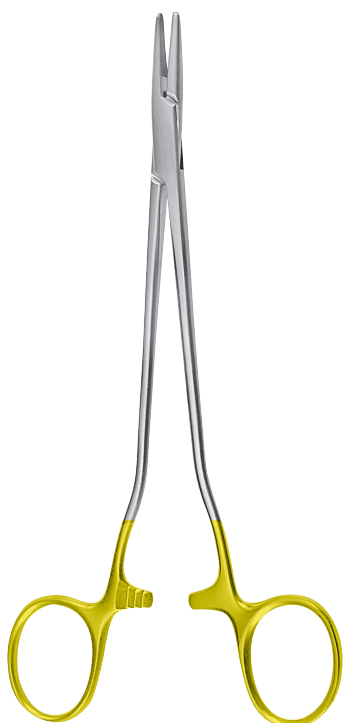

**HEGAR-VASCULAR**

<b>019-610-140</b>	14,0 cm / 5 <sup>1</sup> / <sub>2</sub> "
<b>019-610-180</b>	18,0 cm / 7"
<b>019-610-200</b>	20,0 cm / 8"
<b>019-610-230</b>	23,0 cm / 9"



019

Nadelhalter mit Hartmetalleinlagen  
Needle Holders with tungsten carbide inserts  
Porta-agujas con bocas de carburo tungsteno  
Portaghi con morsi in carburo di tungsteno

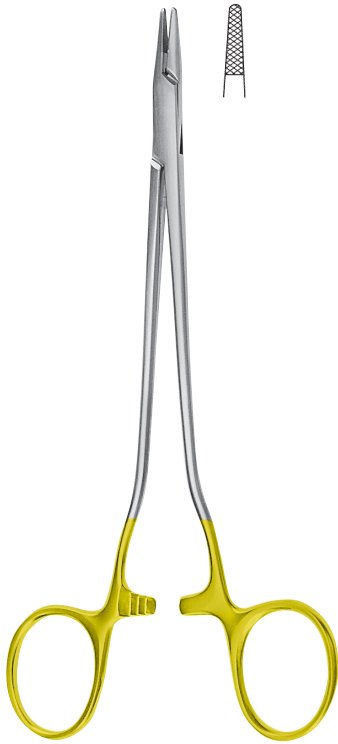

**SENNING**

- 019-620-150** 15,0 cm / 6"
- 019-620-170** 17,0 cm / 6<sup>3</sup>/<sub>4</sub>"
- 019-620-200** 20,0 cm / 8"

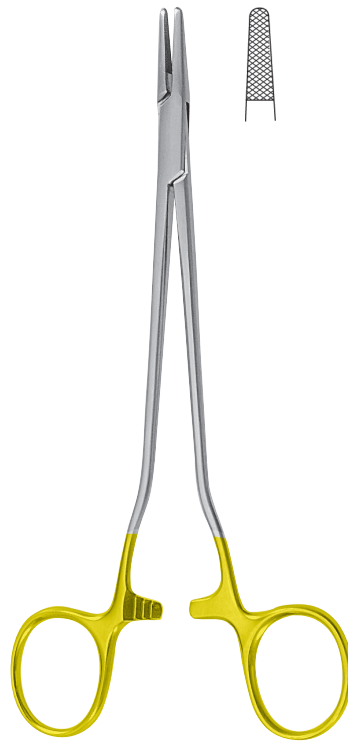

**SAROT**

- 019-630-180** 18,0 cm / 7"
- 019-630-200** 20,0 cm / 8"
- 019-630-230** 23,0 cm / 9"
- 019-630-260** 26,0 cm / 10<sup>1</sup>/<sub>4</sub>"

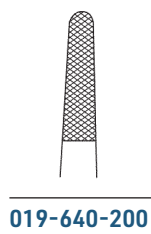
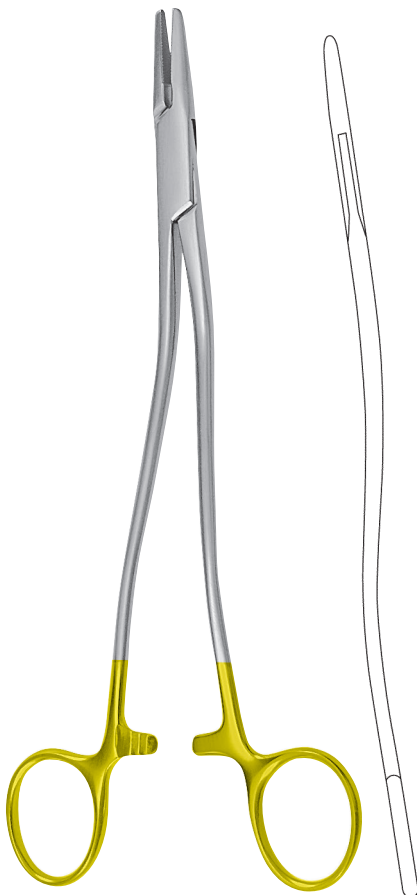

**019-640-200**

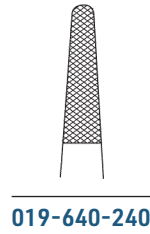

**019-640-240**

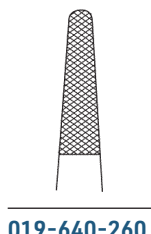

**019-640-260**

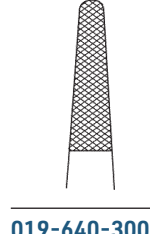

**019-640-300**

**BOZEMANN**

- 019-640-200** 20,0 cm / 8"
- 019-640-240** 24,0 cm / 9<sup>1</sup>/<sub>2</sub>"
- 019-640-260** 26,0 cm / 10<sup>1</sup>/<sub>4</sub>"
- 019-640-300** 30,0 cm / 11<sup>3</sup>/<sub>4</sub>"



019-644-210

019-644-230

**STRATTE**

019-644-210 21,0 cm / 8<sup>1</sup>/<sub>4</sub>"  
 019-644-230 23,0 cm / 9"



**MASSON**

019-650-270 27,0 cm / 10<sup>1</sup>/<sub>4</sub>"



**FINOCHIETTO**

019-651-270 27,0 cm / 10<sup>1</sup>/<sub>4</sub>"



**WANGENSTEEN**

019-654-270 28,0 cm / 11"



019

Nadelhalter mit Hartmetalleinlagen  
Needle Holders with tungsten carbide inserts  
Porta-agujas con bocas de carburo tungsteno  
Portaghi con morsi in carburo di tungsteno

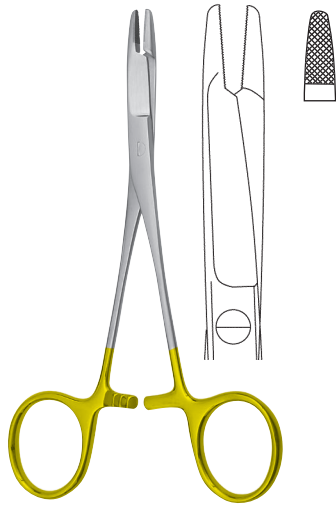

**OLSEN-HEGAR**

- 019-660-115** 11,5 cm / 4<sup>1</sup>/<sub>2</sub>"
- 019-660-140** 14,0 cm / 5<sup>1</sup>/<sub>2</sub>"
- 019-660-170** 17,0 cm / 6<sup>3</sup>/<sub>4</sub>"
- 019-660-185** 18,5 cm / 7<sup>1</sup>/<sub>4</sub>"

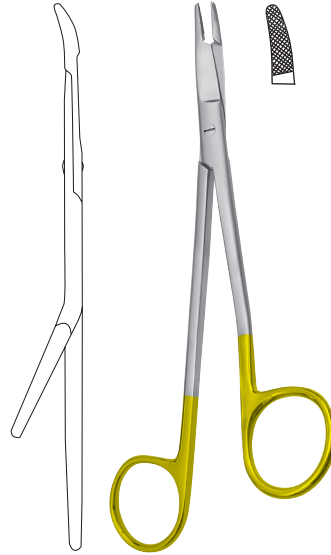

**BABY-GILLIES**

- 019-662-150** 15,0 cm / 6"



**GILLIES**

- 019-664-160** 16,0 cm / 6<sup>1</sup>/<sub>4</sub>"



019-670-140



019-670-170



019-670-200



019-670-240

**MATHIEU**

- |                    |                  |
|--------------------|------------------|
| <b>019-670-140</b> | 14,0 cm / 5 1/2" |
| <b>019-670-170</b> | 17,0 cm / 6 3/4" |
| <b>019-670-200</b> | 20,0 cm / 8"     |
| <b>019-670-240</b> | 24,0 cm / 6 1/2" |

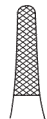

019-672-140



019-672-170



019-672-200

**MATHIEU-KOCHER**

- |                    |                  |
|--------------------|------------------|
| <b>019-672-140</b> | 14,0 cm / 5 1/2" |
| <b>019-672-170</b> | 17,0 cm / 6 3/4" |
| <b>019-672-200</b> | 20,0 cm / 8"     |



019

Nadelhalter mit Hartmetalleinlagen  
 Needle Holders with tungsten carbide inserts  
 Porta-agujas con bocas de carburo tungsteno  
 Portaghi con morsi in carburo di tungsteno



019-674-140



019-674-170



019-674-200



019-680-140



019-680-170



019-680-200

**MATHIEU-RYDER**

- 019-674-140** 14,0 cm / 5 1/2"
- 019-674-170** 17,0 cm / 6 3/4"
- 019-674-200** 20,0 cm / 8"

**MATHIEU**

- 019-680-140** 14,0 cm / 5 1/2"
- 019-680-170** 17,0 cm / 6 3/4"
- 019-680-200** 20,0 cm / 8"



019-690-160



019-690-180



019-690-200

**LANGENBECK**

- 019-690-160** 16,0 cm / 6 1/4"
- 019-690-180** 18,0 cm / 7"
- 019-690-200** 20,0 cm / 8"





**CRILE**

**019-696-150** 15,0 cm / 6"



**TOENNIS**

**019-696-180** 18,0 cm / 7"



**LICHTENBERG**

**019-700-170** 17,0 cm / 6<sup>3</sup>/<sub>4</sub>"  
**019-700-200** 20,0 cm / 8"



**LICHTENBERG**

**019-701-170** 17,0 cm / 6<sup>3</sup>/<sub>4</sub>"



mit langem Hals  
 with long neck  
 con cuello largo  
 con collo lungo

**HÖSEL**

**019-710-200** 20,0 cm / 8"



019

Nadelhalter mit Hartmetalleinlagen  
Needle Holders with tungsten carbide inserts  
Porta-agujas con bocas de carburo tungsteno  
Portaghi con morsi in carburo di tungsteno



019-714-200

019-714-230

**ZWEIFEL**

019-714-200 20,0 cm / 8"  
019-714-230 23,0 cm / 9"



mit langem Hals  
with long neck  
con cuello largo  
con collo lungo

**HÖSEL**

019-720-260 26,0 cm / 10<sup>3</sup>/<sub>4</sub>"

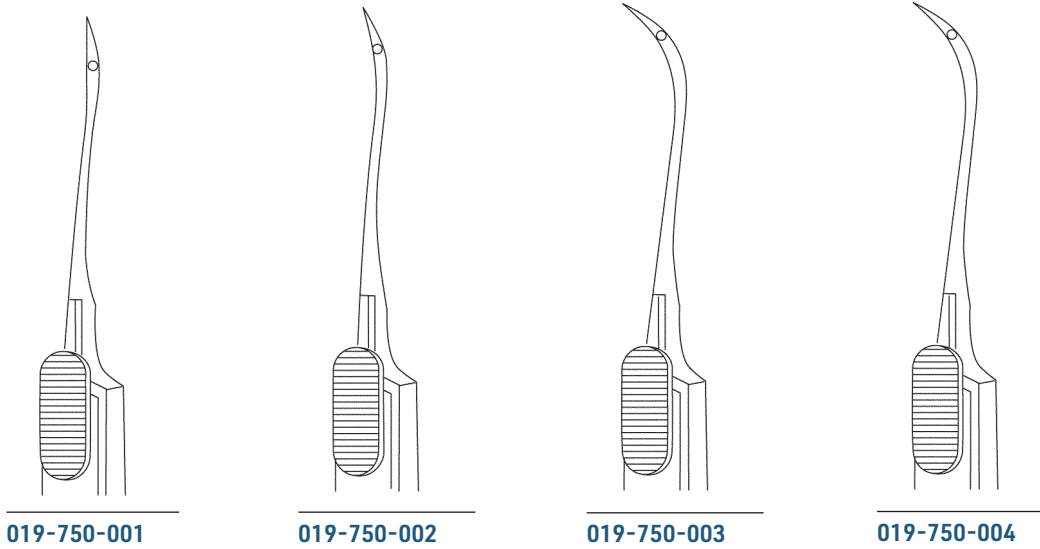

019-750-001

019-750-002

019-750-003

019-750-004

**REVERDIN**

019-750-001 - 019-750-004 14,0 cm / 5 1/2"

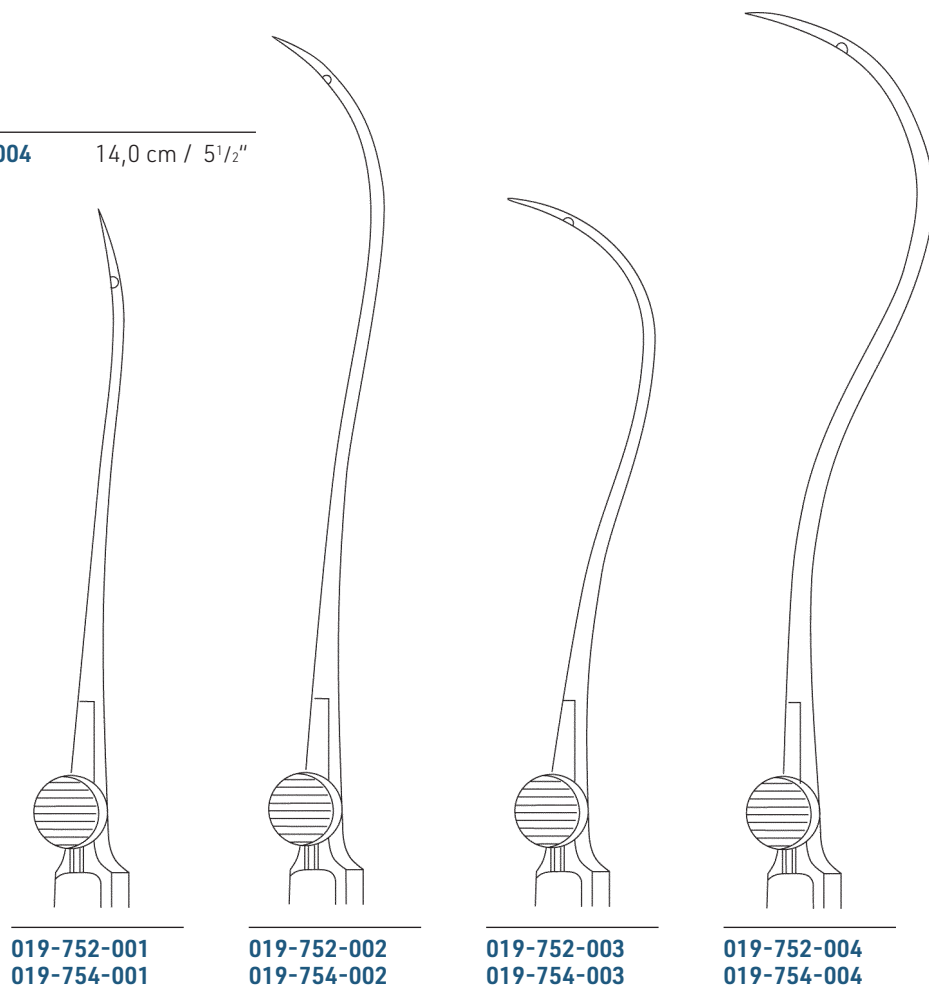

019-752-001  
019-754-001

019-752-002  
019-754-002

019-752-003  
019-754-003

019-752-004  
019-754-004

**REVERDIN**

019-752-001 - 019-752-004 19,0 cm / 7 1/2"  
 019-754-001 - 019-754-004 23,0 cm / 9"



019

Unterbindungsnadeln  
Ligature Needles  
Agujas para ligaduras  
Aghi per legatura



Fig. 1  
**019-761-001**

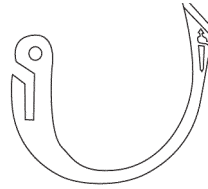

Fig. 2  
**019-761-002**

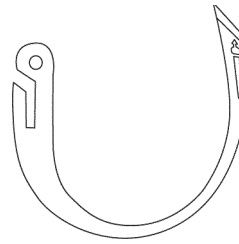

Fig. 3  
**019-761-003**

komplett mit Nadel Fig.1  
complete with needle Fig.1  
completo con aguja Fig.1  
completo con ago Fig.1

**YOUNG**

**019-760-240** 24,0 cm / 9 1/2"



**SCHMIEDEN**

**019-771-240** 24,0 cm / 9 1/2"

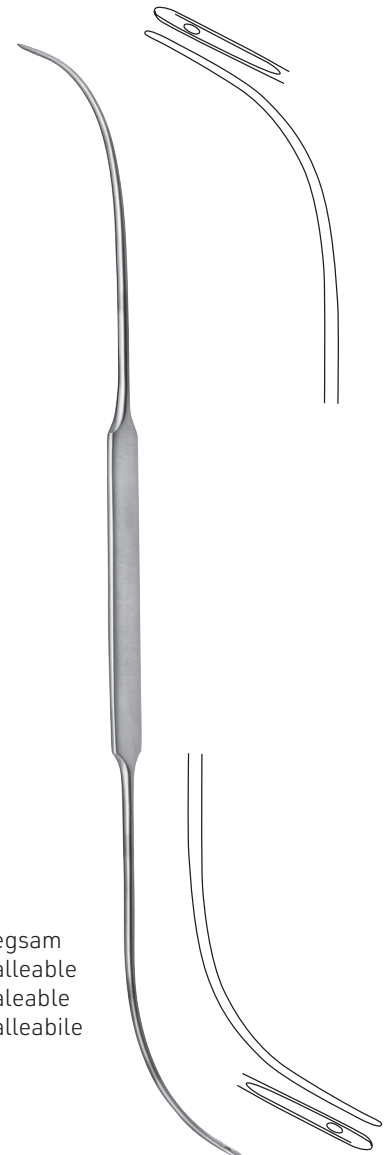

biegsam  
malleable  
maleable  
malleabile

**SCHMIEDEN-DICK**

**019-773-300** 30,0 cm / 11 3/4"



**019-781-200** 20,0 cm / 8"

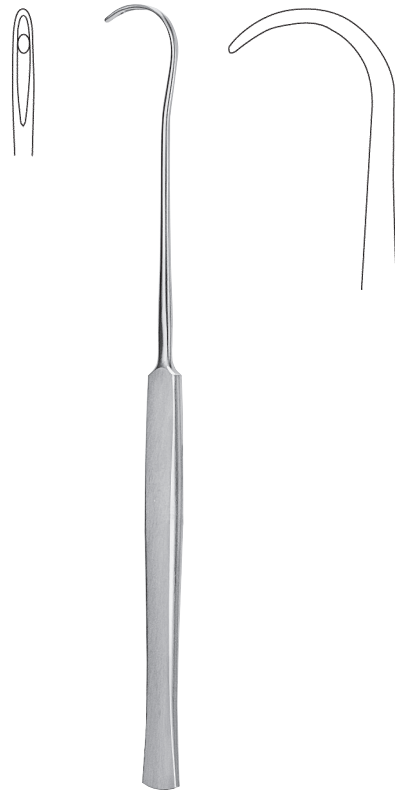

**COOPER**

**019-783-190** 19,0 cm / 7 1/2"



fein  
 für die rechte Hand  
 delicate  
 for right hand  
 fina  
 para la mano derecha  
 fino  
 per la mano destra

**KRONECKER**

**019-785-130** 13,0 cm / 5 1/8"

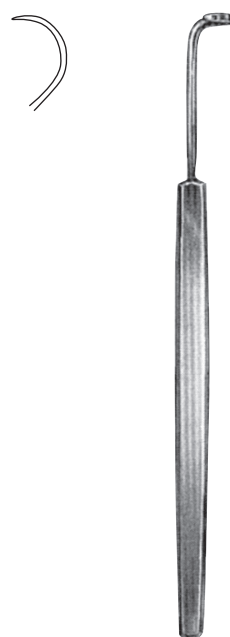
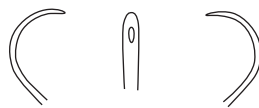

fein  
 für die linke Hand  
 delicate  
 for left hand  
 fina  
 para la mano izquierda  
 fino  
 per la mano sinistra

**KRONECKER**

**019-787-130** 13,0 cm / 5 1/8"



019

Unterbindungsnadeln  
Ligature Needles  
Agujas para ligaduras  
Aghi per legatura

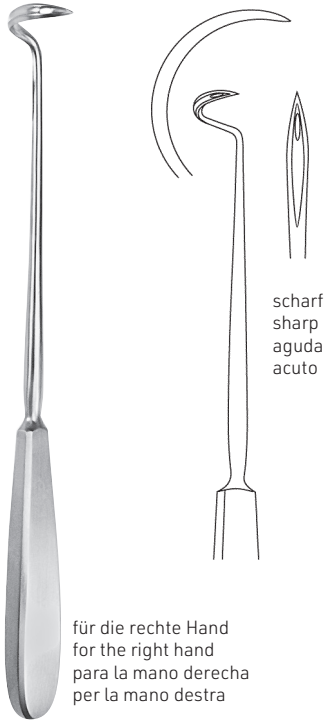

scharf  
sharp  
aguda  
acuto

für die rechte Hand  
for the right hand  
para la mano derecha  
per la mano destra

**DESCHAMPS**

**019-800-200** 20,0 cm / 8"

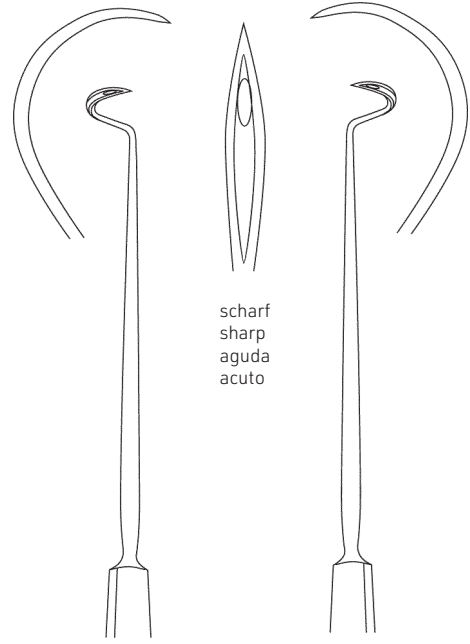

scharf  
sharp  
aguda  
acuto

**019-800-210**  
**019-800-270**

für die rechte Hand  
for the right hand  
para la mano derecha  
per la mano destra

**019-801-210**  
**019-801-270**

für die linke Hand  
for the left hand  
para la mano izquierda  
per la mano sinistra

**DESCHAMPS**

**019-800-210 - 019-801-210** 21,0 cm / 8 1/4"  
**019-800-270 - 019-801-270** 27,0 cm / 10 1/4"

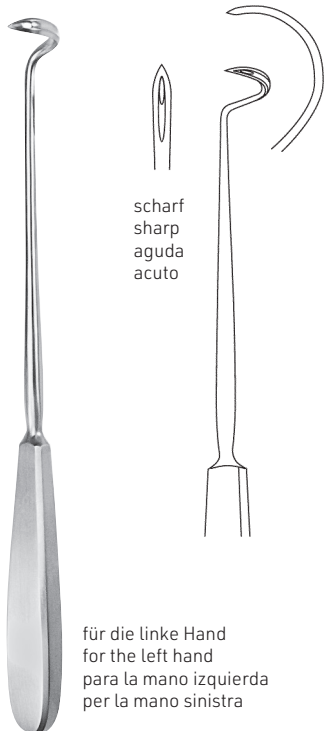

scharf  
sharp  
aguda  
acuto

für die linke Hand  
for the left hand  
para la mano izquierda  
per la mano sinistra

**DESCHAMPS**

**019-801-200** 20,0 cm / 8"

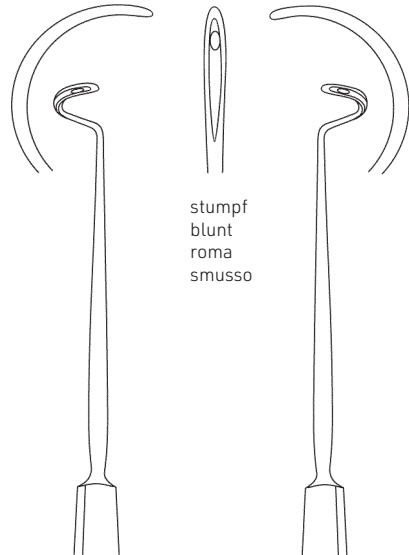

stumpf  
blunt  
roma  
smusso

**019-810-200**

für die rechte Hand  
for the right hand  
para la mano derecha  
per la mano destra

**019-811-200**

für die linke Hand  
for the left hand  
para la mano izquierda  
per la mano sinistra

**DESCHAMPS**

20,0 cm / 8"

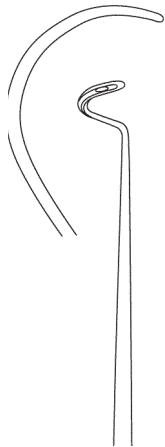

stumpf  
 blunt  
 roma  
 smusso



**019-810-210**  
**019-810-240**

für die rechte Hand  
 for the right hand  
 para la mano derecha  
 per la mano destra

**019-811-210**  
**019-811-240**

für die linke Hand  
 for the left hand  
 para la mano izquierda  
 per la mano sinistra

**DESCHAMPS**

**019-810-210 - 019-811-210** 21,0 cm / 8<sup>1</sup>/<sub>4</sub>"  
**019-810-240 - 019-811-240** 24,0 cm / 9<sup>1</sup>/<sub>2</sub>"

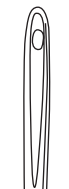
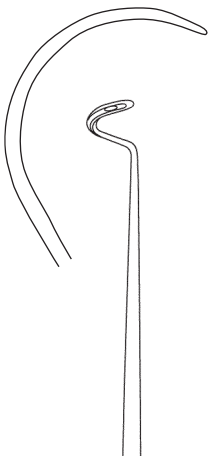

stumpf  
 blunt  
 roma  
 smusso

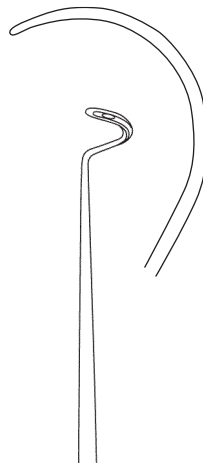

**019-810-270**  
**019-810-280**

für die rechte Hand  
 for the right hand  
 para la mano derecha  
 per la mano destra

**019-811-270**  
**019-811-280**

für die linke Hand  
 for the left hand  
 para la mano izquierda  
 per la mano sinistra

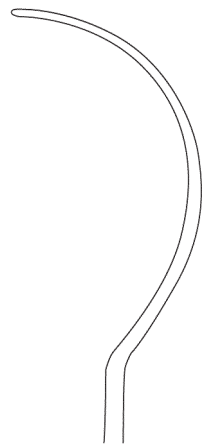

**019-820-001**

**019-820-002**

**DESCHAMPS**

**019-810-270 - 019-811-270** 24,0 cm / 9<sup>1</sup>/<sub>2</sub>"  
**019-810-280 - 019-811-280** 28,0 cm / 11"

**BRUNNER**

**019-820-001 - 019-820-002** 30,0 cm / 11<sup>3</sup>/<sub>4</sub>"



019

Unterbindungsnadeln, Führungshohlsonden  
Ligature Needles, Ligature Conductors  
Agujas para ligaduras, Sondas conductoras  
Aghi per legatura, Sonde conduttrici



019-824-001

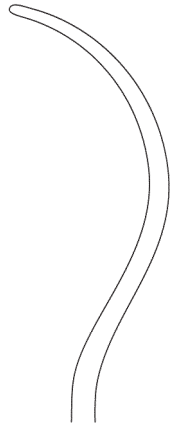

019-824-002

**BRUNNER**

019-824-001 - 019-824-002 30,0 cm / 11<sup>3</sup>/<sub>4</sub>"

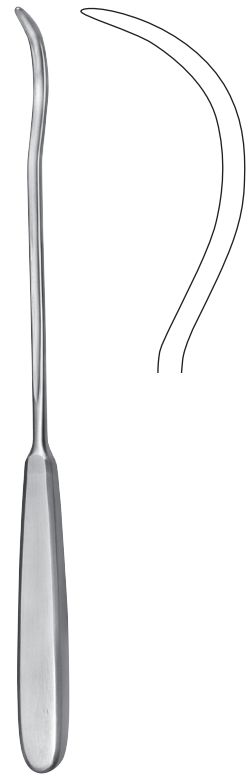

**KIRSCHNER**

019-829-255 25,5 cm / 10"

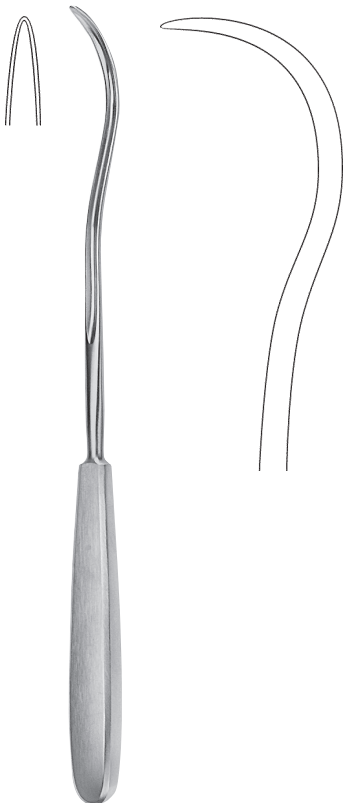

**KIRSCHNER**

019-829-280 28,0 cm / 11"

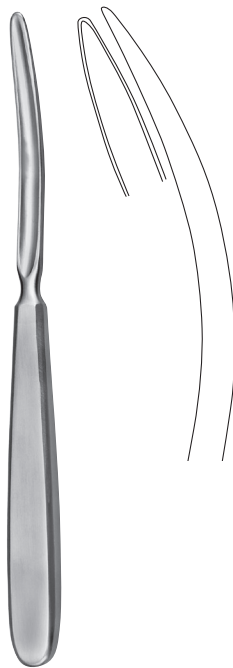

**FRIMED**

019-833-195 19,5 cm / 7<sup>3</sup>/<sub>4</sub>"



**KÖNIG**

019-841-001 19,5 cm / 7<sup>3</sup>/<sub>4</sub>"





**KÖNIG**

**019-841-002** 19,5 cm / 7<sup>3</sup>/<sub>4</sub>"



**KÖNIG**

**019-841-003** 19,5 cm / 7<sup>3</sup>/<sub>4</sub>"



**SCHMIEDEN**

**019-845-190** 19,0 cm / 7<sup>1</sup>/<sub>2</sub>"



**SCHMIEDEN-PAYR**

**019-847-190** 19,0 cm / 7<sup>1</sup>/<sub>2</sub>"



**PAYR**

**019-850-220** 22,0 cm / 8<sup>5</sup>/<sub>8</sub>"



**PAYR**

**019-851-220** 22,0 cm / 8<sup>5</sup>/<sub>8</sub>"



019

Führungshohlsonden  
Ligature Conductors  
Sondas conductoras  
Sonde conduttrici



**MOD. WIEN**

**019-856-235** 23,5 cm / 9<sup>1</sup>/<sub>4</sub>"



**BOZEMANN**

**019-858-210** 21,0 cm / 8<sup>1</sup>/<sub>4</sub>"



**FRIMED**

**019-860-230** 23,0 cm / 9"



**BRUNNER**

**019-871-180** 18,0 cm / 7"  
**019-871-270** 27,0 cm / 10<sup>3</sup>/<sub>4</sub>"



**KIRSCHNER**

**019-873-270** 27,0 cm / 10<sup>3</sup>/<sub>4</sub>"



**FERROZELL**

**019-875-190** 19,0 cm / 7<sup>1</sup>/<sub>2</sub>"



**FERROZELL**

**019-877-185** 18,5 cm / 7<sup>1</sup>/<sub>4</sub>"



**FERROZELL**

**019-878-240** 24,0 cm / 9<sup>1</sup>/<sub>2</sub>"



kräftig, mit Klammerschiene  
heavy pattern, with clip holder  
modelo fuerte, con porta-agrafas  
modello forte, con porta-agrafas

**CHILDE**

**019-901-180** 18,0 cm / 7"



**MICHEL**

**019-902-120** 12,0 cm / 4<sup>3</sup>/<sub>4</sub>"



019

Wundklammerpinzetten, Wundklammerzangen  
 Clip Applying Forceps  
 Pinzas aplicadoras para agrafes  
 Pinze per applicare le agrafe

zum Anlegen und Abnehmen der Klammern  
 for applying and removal of clips  
 para aplicar y quitar agrafes  
 per applicare e togliere le agrafe



**HEGENBARTH**

**019-904-120** 12,0 cm / 4<sup>3</sup>/<sub>4</sub>"



**WACHENFELDT**

**019-906-125** 12,5 cm / 5"



**MICHEL**

**019-910-120** 12,0 cm / 4<sup>3</sup>/<sub>4</sub>"

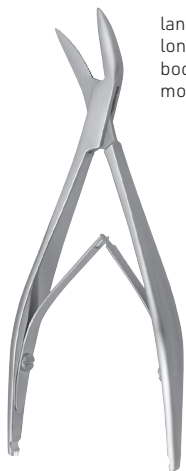

langes Maul  
 long jaw  
 boca larga  
 morso lungo

**MOD. MICHEL**

**019-912-120** 12,0 cm / 4<sup>3</sup>/<sub>4</sub>"



**COLLIN**

**019-914-130** 13,0 cm / 5"

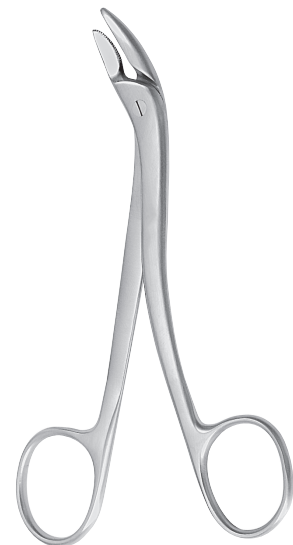

**RICHTER-HEATH**

**019-915-140** 14,0 cm / 5<sup>1</sup>/<sub>2</sub>"

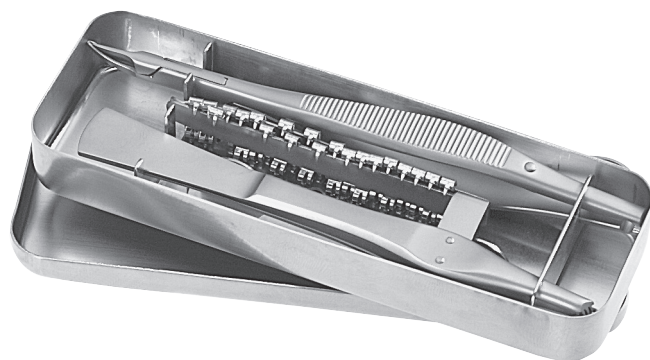

## SET

**019-930-000** 130x45x18 mm

Wundklammer-Besteck, komplett, im Metalletui, bestehend aus:

- 1 Michel Wundklammerzängchen
- 1 Wachenfeldt Wundrand-Faßpinzette, mit Klammerhalter
- 50 Michel Wundklammern, 14 x 3 mm
- 1 Plastikschatztasche

Suture Clip Set, complete, in metal case, consisting of:

- 1 Michel suture clip forceps
- 1 Wachenfeldt approximation forceps, with clip holder
- 50 Michel suture clips, 14 x 3 mm
- 1 protection pouch, plastic

Estuche de agrafes, completo, en caja metálica, compuesto de:

- 1 Michel pinza para agrafes
- 1 Wachenfeldt pinza aproximadora con porta-agrafes
- 50 Michel agrafes, 14 x 3 mm
- 1 bolsa de protecció, plástico

Set per sutura cutanea, completo, in contenitore metallico

- composto di:
- 1 pinza per agrafes Michel
  - 1 pinza Wachenfeldt per avvicinare i margini della ferita, con port' agrafes
  - 50 agrafes Michel, 14 x 3 mm
  - 1 busta protettiva in plastica